



GFX/XCN Display Series

INSTALLATION AND USER GUIDE

NOTE – This document provides details for the GFX-350, GFX-750, XCN-750, and XCN-1050 Displays. For complete details, contact your authorized reseller.

Version 1.00
Revision A
December 2019

Legal Notices

Agriculture Business Area

Trimble Agriculture Division
10368 Westmoor Drive
Westminster, CO 80021-2712
USA

www.trimble.com

Copyright and Trademarks

© 2019, Trimble Inc. All rights reserved.

Trimble, and the Globe & Triangle logo are trademarks of Trimble Inc., registered in the United States and in other countries. Field-IQ is a trademark of Trimble Inc. Developed under a License of the European Union and the European Space Agency.

All other trademarks are the property of their respective owners.

Official Language

THE OFFICIAL LANGUAGE OF THESE TERMS AND CONDITIONS IS ENGLISH. IN THE EVENT OF A CONFLICT BETWEEN ENGLISH AND OTHER LANGUAGE VERSIONS, THE ENGLISH LANGUAGE SHALL CONTROL.

Release Notice

This is the December 2019 release (Revision A) of the *GFX/XCN Display Series Installation and User Guide*. It applies to version 1.00 of the GFX/XCN Display Series.

The following limited warranties give you specific legal rights. You may have others, which vary from state/jurisdiction to state/jurisdiction.

Product Limited Warranty

Trimble warrants that this Trimble product and its internal components (the "Product") shall be free from defects in materials and workmanship and will substantially conform to Trimble's applicable published specifications for the Product for a period of two (2) years, starting from the earlier of (i) the date of installation, or (ii) six (6) months from the date of product shipment from Trimble. This warranty applies only to the Product if installed by Trimble or a distributor authorized by Trimble to perform Product installation services.

Software Components and Enhancements

All Product software components (sometimes hereinafter also referred to as "Software") are licensed and not sold. Any Software accompanied by a separate End User License Agreement ("EULA") shall be governed by the terms, conditions, restrictions and limited warranty terms of such EULA notwithstanding the preceding paragraph. During the limited warranty period you will be entitled to receive, at no

additional charge, such Fix Updates and Minor Updates to the Product software as Trimble may develop for general release, subject to the procedures for delivery to purchasers of Trimble products generally. If you have purchased the Product from an authorized Trimble distributor rather than from Trimble directly, Trimble may, at its option, forward the software Fix Update or Minor Update to the Trimble distributor for final distribution to you. Major Upgrades, new products, or substantially new software releases, as identified by Trimble are expressly excused from this enhancement process and limited warranty. Receipt of software updates shall not serve to extend the limited warranty period.

For purposes of this warranty the following definitions shall apply: (1) "Fix Update" means an error correction or other update created to fix a previous software version that does not substantially conform to its published specifications; (2) "Minor Update" occurs when enhancements are made to current features in a software program; and (3) "Major Upgrade" occurs when significant new features are added to software, or when a new product containing new features replaces the further development of a current product line. Trimble reserves the right to determine, in its sole discretion, what constitutes a significant new feature and Major Upgrade.

Warranty Remedies

Trimble's sole liability and your exclusive remedy under the warranties set forth above shall be, at Trimble's option, to repair or replace any Product that fails to conform to such warranty ("Nonconforming Product"), and/or issue a cash refund up to the purchase price paid by you for any such Nonconforming Product, excluding costs of installation, upon your return of the Nonconforming Product to Trimble in accordance with Trimble's standard return material authorization process. Such remedy may include reimbursement of the cost of repairs for damage to third-party equipment onto which the Product is installed, if such damage is found to be directly caused by the Product as reasonably determined by Trimble following a root cause analysis.

Warranty Exclusions and Disclaimer

These warranties shall be applied only in the event and to the extent that (i) the Products and Software are properly and correctly installed, configured, interfaced, maintained, stored, and operated in accordance with Trimble's relevant operator's manual and specifications, and; (ii) the Products and Software are not modified or misused. The preceding warranties shall not apply to, and Trimble shall not be responsible for defects or performance problems resulting from (i) the combination or utilization of the Product or Software with hardware or software products, information, data, systems, interfaces or devices not made, supplied or specified by Trimble; (ii) the operation of the Product or

Software under any specification other than, or in addition to, Trimble's standard specifications for its products; (iii) the unauthorized, installation, modification, or use of the Product or Software; (iv) damage caused by accident, lightning or other electrical discharge, fresh or salt water immersion or spray; or (v) normal wear and tear on consumable parts (e.g., batteries). Trimble does not warrant or guarantee the results obtained through the use of the Product.

THE WARRANTIES ABOVE STATE TRIMBLE'S ENTIRE LIABILITY, AND YOUR EXCLUSIVE REMEDIES, RELATING TO PERFORMANCE OF THE PRODUCTS AND SOFTWARE. EXCEPT AS OTHERWISE EXPRESSLY PROVIDED HEREIN, THE PRODUCTS, SOFTWARE, AND ACCOMPANYING DOCUMENTATION AND MATERIALS ARE PROVIDED "AS-IS" AND WITHOUT EXPRESS OR IMPLIED WARRANTY OF ANY KIND BY EITHER TRIMBLE INC. OR ANYONE WHO HAS BEEN INVOLVED IN ITS CREATION, PRODUCTION, INSTALLATION, OR DISTRIBUTION INCLUDING, BUT NOT LIMITED TO, THE IMPLIED WARRANTIES OF MERCHANTABILITY AND FITNESS FOR A PARTICULAR PURPOSE, TITLE, AND NONINFRINGEMENT. THE STATED EXPRESS WARRANTIES ARE IN LIEU OF ALL OBLIGATIONS OR LIABILITIES ON THE PART OF TRIMBLE ARISING OUT OF, OR IN CONNECTION WITH, ANY PRODUCTS OR SOFTWARE. SOME STATES AND JURISDICTIONS DO NOT ALLOW LIMITATIONS ON DURATION OR THE EXCLUSION OF AN IMPLIED WARRANTY, SO THE ABOVE LIMITATION MAY NOT APPLY TO YOU.

TRIMBLE INC. IS NOT RESPONSIBLE FOR THE OPERATION OR FAILURE OF OPERATION OF GPS SATELLITES OR THE AVAILABILITY OF GPS SATELLITE SIGNALS.

Limitation of Liability

TRIMBLE'S ENTIRE LIABILITY UNDER ANY PROVISION HEREIN SHALL BE LIMITED TO THE AMOUNT PAID BY YOU FOR THE PRODUCT OR SOFTWARE LICENSE. TO THE MAXIMUM EXTENT PERMITTED BY APPLICABLE LAW, IN NO EVENT SHALL TRIMBLE OR ITS SUPPLIERS BE LIABLE FOR ANY INDIRECT, SPECIAL, INCIDENTAL OR CONSEQUENTIAL DAMAGES WHATSOEVER UNDER ANY CIRCUMSTANCE OR LEGAL THEORY RELATING IN ANY WAY TO THE PRODUCTS, SOFTWARE AND ACCOMPANYING DOCUMENTATION AND MATERIALS, (INCLUDING, WITHOUT LIMITATION, DAMAGES FOR LOSS OF BUSINESS PROFITS, BUSINESS INTERRUPTION, LOSS OF BUSINESS INFORMATION, OR ANY OTHER PECUNIARY LOSS), REGARDLESS WHETHER TRIMBLE HAS BEEN ADVISED OF THE POSSIBILITY OF ANY SUCH LOSS AND REGARDLESS OF THE COURSE OF DEALING WHICH DEVELOPS OR HAS DEVELOPED BETWEEN YOU AND TRIMBLE. BECAUSE SOME STATES AND JURISDICTIONS DO NOT ALLOW THE EXCLUSION OR LIMITATION OF LIABILITY FOR CONSEQUENTIAL OR INCIDENTAL DAMAGES, THE ABOVE LIMITATION MAY NOT APPLY TO YOU.

NOTE: THE ABOVE LIMITED WARRANTY PROVISIONS MAY NOT APPLY TO PRODUCTS OR SOFTWARE PURCHASED IN THE EUROPEAN UNION. PLEASE CONTACT YOUR TRIMBLE DEALER FOR APPLICABLE WARRANTY INFORMATION.

Notices

Class B Statement – Notice to Users.

This equipment has been tested and found to comply with the limits for a Class B digital device, pursuant to Part 15 of the FCC rules. These limits are designed to provide reasonable protection against harmful interference in a residential installation. This equipment generates, uses, and can radiate radio frequency energy and, if not installed and used in accordance with the instructions, may cause harmful interference to radio communication. However, there is no guarantee that interference will not occur in a particular installation. If this equipment does cause harmful interference to radio or television reception, which can be determined by turning the equipment off and on, the user is encouraged to try to correct the interference by one or more of the following measures:

- Reorient or relocate the receiving antenna.
- Increase the separation between the equipment and the receiver.
- Connect the equipment into an outlet on a circuit different from that to which the receiver is connected.
- Consult the dealer or an experienced radio/TV technician for help.

FCC Caution: Changes and modifications not expressly approved by the manufacturer or registrant of this equipment can void your authority to operate this equipment.

This device complies with Part 15 of the FCC Rules. Operation is subject to the following two conditions: (1) This device may not cause harmful interference, and (2) this device must accept any interference received, including interference that may cause undesired operation.

IMPORTANT NOTE:

FCC Radiation Exposure Statement:

This equipment complies with FCC radiation exposure limits set forth for an uncontrolled environment. This equipment should be installed and operated with minimum distance 20cm between the radiator & your body.

This transmitter must not be co-located or operating in conjunction with any other antenna or transmitter.

Contains FCC ID: Z64-2564N

Industry Canada statement

This device complies with Industry Canada licence-exempt RSS standard(s). Operation is subject to the following two conditions:

- (1) this device may not cause interference, and
- (2) this device must accept any interference, including interference that may cause undesired operation of the device.

Le présent appareil est conforme aux CNR d'Industrie Canada applicables aux appareils radio exempts de licence. L'exploitation est autorisée aux deux conditions suivantes :

- (1) l'appareil ne doit pas produire de brouillage, et
- (2) l'utilisateur de l'appareil doit accepter tout brouillage radioélectrique subi, même si le brouillage est susceptible d'en compromettre le fonctionnement.

Radiation Exposure Statement:

The product comply with the Canada portable RF exposure limit set forth for an uncontrolled environment and are safe for intended operation as described in this manual. The further RF exposure reduction can be achieved if the product can be kept as far as possible from the user body or set the device to lower output power if such function is available.

Déclaration d'exposition aux radiations:

Le produit est conforme aux limites d'exposition pour les appareils portables RF pour les Etats-Unis et le Canada établies pour un environnement non contrôlé. Le produit est sûr pour un fonctionnement tel que décrit dans ce manuel. La réduction aux expositions RF peut être augmentée si l'appareil peut être conservé aussi loin que possible du corps de l'utilisateur ou que le dispositif est réglé sur la puissance de sortie la plus faible si une telle fonction est disponible.

Contains IC: 4511-2564N

Notice to Our European Union Customers

For product recycling instructions and more information, please go to:

http://www.trimble.com/Corporate/Environmental_Compliance.aspx

Recycling in Europe: To recycle Trimble WEEE, Call +31 497 53 2430, and ask for the "WEEE Associate"

Or

Mail a request for recycling instructions to:

Trimble Europe BV
c/o Menlo Worldwide Logistics
Meerheide 45
5521 DZ Eersel, NL



La operación de este equipo está sujeta a las siguientes dos condiciones: (1) es posible que este equipo o dispositivo no cause interferencia perjudicial y (2) este equipo o dispositivo debe aceptar cualquier interferencia, incluyendo la que pueda causar su operación no deseada.

Aviso para México

Safety Information

Always follow the instructions that accompany a Warning or Caution. The information they provide is intended to minimize the risk of personal injury and/or damage to property. In particular, observe safety instructions that are presented in the following format:

 **WARNING** – This alert warns of a potential hazard which, if not avoided, could result in severe injury or even death.

 **CAUTION** – This alert warns of a potential hazard or unsafe practice which, if not avoided, could result in injury or property damage or irretrievable data loss.

***NOTE** – An absence of specific alerts does not mean that there are no safety risks involved.*

Intended Use

Warnings

 **WARNING** – When you are working on the vehicle’s hydraulic systems, vehicle attachments that are suspended can drop. If you are working around the vehicle, you could suffer serious injury if an attachment dropped on you. To avoid this risk, lower all vehicle attachments to the ground before you begin work.

 **WARNING** – If someone else attempts to drive the vehicle while you are working on or under it, you can suffer serious or fatal injuries. To avoid this possibility, install a lockout box on the battery terminal to prevent the battery from being reconnected, remove the key from the vehicle’s ignition switch, and attach a “Do not operate” tag in the cab.

 **WARNING** – Agricultural chemicals can pose serious health risks. If the vehicle has been used to apply agricultural chemicals, steam clean the vehicle to remove any chemical residue from the areas of the vehicle where you will be working.

 **WARNING** – Vehicle cabs can be quite high in the air. To avoid potentially serious injury through falling from this height, always use the steps and handrails, and face the vehicle, when you enter or exit it.

 **WARNING** – Vehicles must be parked on a hard, level surface with the front and rear wheels blocked. The steering must be aligned straight ahead. For articulated vehicles, articulation locks must be installed.

Cautions

 **CAUTION** – When the vehicle has been running, parts of the vehicle, including the engine and exhaust, can become extremely hot and can cause serious burns. To avoid burns, allow hot machine parts to cool before you begin working on them.

 **CAUTION** – The system installation may bring you into contact with chemical substances, such as oil, which can cause poisoning. Wash your hands thoroughly after you finish working on the system.

 **CAUTION** – Battery posts, terminals, and related accessories contain lead and lead compounds, which can cause serious illness. To avoid ingesting lead, wash your hands thoroughly after touching the battery. Take care not to short-circuit the battery with tools and/or by the incorrect fitting of cables as fire, burns, and damage can occur.

 **CAUTION** – Always wear protective equipment appropriate to the job conditions and the nature of the vehicle. This includes wearing protective glasses when you use pressurized air or water, and correct protective welder's clothing when welding. Avoid wearing loose clothing or jewelry that can catch on machine parts or tools.

 **CAUTION** – Parts of the vehicle may be under pressure. To avoid injury from pressurized parts, relieve all pressure in oil, air, and water systems before you disconnect any lines, fittings, or related items. To avoid being sprayed by pressurized liquids, hold a rag over fill caps, breathers, or hose connections when you remove them. Do not use your bare hands to check for hydraulic leaks. Use a board or cardboard instead.

-
- ⚠ CAUTION** – Do not direct pressurized water at:
- electronic or electrical components or connectors
 - bearings
 - hydraulic seals
 - fuel injection pumps
 - any other sensitive parts or components



Set the hose pressure as low as practicable, and spray at a 45° to 90° angle. Keep the nozzle of the power washer away from the machine at the distance recommended by the manufacturer.

⚠ CAUTION – To prevent damage to the system, make sure that no wires or hoses interfere with or catch on any mechanical linkages, or contact any machine parts that get hot.

Contents

Safety Information	i
Intended Use	i
Warnings	i
Cautions	ii
Contents	iv
1 Precision-IQ User Guide	i
The Precision-IQ Home Screen	ii
Precision-IQ Home Screen Resource Tiles	iii
GNSS	iii
Vehicle	iii
Implement	iv
Material	v
Field	v
Task	v
The Run Screen	vii
Ending a Run	vii
Run Screen Guidance Patterns	viii
Guidance Patterns	viii
Auto Close	viii
Landmarks	ix
Common Precision-IQ Icons	x
Data Transfer	xii
Using App Central	xii
System Information	xii
Display Systems Supported by Precision-IQ	xiv
GFX-750 and XCN-1050 Displays	xiv
GFX-350 and XCN-750 Displays	xv
2 NAV-500 Guidance Controller Installation	16
Introduction to the NAV-500 Guidance Controller	17
NAV-500 Basic System Diagram	18
Required Components for Mounting the NAV-500 Guidance Controller	19
Preparing the Vehicle for Installation	20
NAV-500 Guidance Controller LED Indicators	21
LED color: None	21

LED color: Red	21
LED color: Red/Orange	22
LED color: Red/Green	22
LED color: Orange	22
LED color: Green	22
Fatal Error	23
Mounting the NAV-500 Guidance Controller	24
Orientation of the Guidance Controller	24
VHB (Double-Sided Tape) Style Mounting	24
All mounting types – Connecting the cables	27
NAV-500 Guidance Controller Firmware	27
Manually Installing Licenses to a NAV-500 Guidance Controller	27
3 NAV-900 Guidance Controller Installation	29
Introduction to the NAV-900 Guidance Controller	30
NAV-900 Basic System Diagram	31
Required Components for Mounting the NAV-900 Guidance Controller	32
Optional Accessories for Mounting	32
Ag-820 Radio System	33
Preparing the Vehicle for Installation	34
NAV-900 Guidance Controller LED Indicators	35
LED color: None	36
LED color: Red	36
LED color: Red/Orange	36
LED color: Red/Green	37
LED color: Orange	37
LED color: Green	37
Fatal error	38
Mounting the NAV-900 Guidance Controller	39
Orientation of the Guidance Controller	39
NAV-900 Guidance Controller Mounting Options	39
Attaching the Base Mounting Plate	40
VHB (Double-Sided Tape) Style Mounting	40
Factory-Fitted Specific Mounting Options	45
Spar Mounting Method	52
All mounting types – Connecting the cables	58
NAV-900 Guidance Controller Firmware	59
Manually Installing Licenses to a NAV-900 Guidance Controller	59

Precision-IQ User Guide

- ▶ The Precision-IQ Home Screen
- ▶ Precision-IQ Home Screen Resource Tiles
- ▶ The Run Screen
- ▶ Run Screen Guidance Patterns
- ▶ Common Precision-IQ Icons
- ▶ Data Transfer
- ▶ Using App Central
- ▶ Display Systems Supported by Precision-IQ

The Trimble® Precision-IQ™ field application for the supported displays is an easy-to-use advanced field management system. From the Launcher screen, tap the **Precision-IQ** icon to launch the application:





The Precision-IQ Home Screen

Tap the Precision-IQ icon to launch the application.

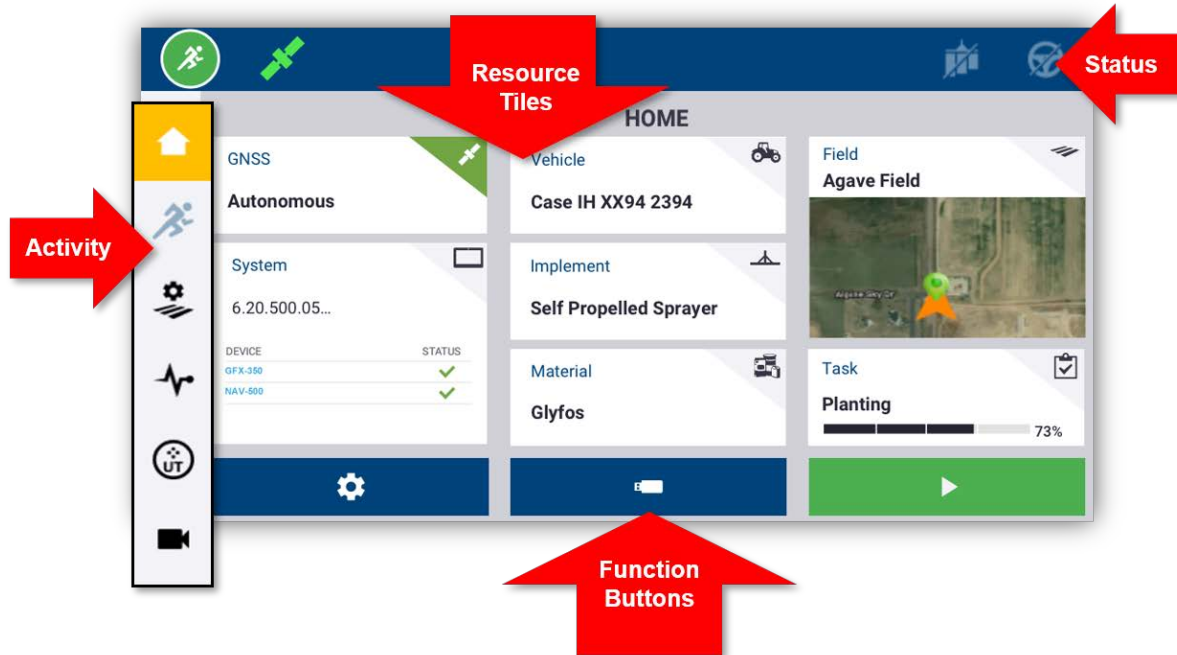

The Home screen displays by default:



Emergency Stop - Tap the Emergency Stop icon  from any screen to stop all activities controlled by the display.

Precision-IQ Home Screen Resource Tiles

Tap the resource tile on the Home screen to configure and select the appropriate Precision-IQ resource.

CAUTION – Take care when setting up these details. The values you set in these steps are critical for in-field system performance and data integrity during run time operations.

NOTE – For details on how to configure and select Precision-IQ resources, contact your authorized Trimble Reseller

GNSS

The **GNSS** tile identifies the correction services you will be using in the Run screen. A subscription may be required in support of the correction services configured.

The GNSS tile shows the status of the satellite connection. **Green** indicates satisfactory coverage:



By default, GNSS is set up for **Autonomous** correction. Tap the **GNSS** icon in the upper-left corner of the status bar for a quick view of the guidance corrections in use:



Vehicle

Precision-IQ provides a variety of vehicle types you can select for the task you need to complete. Tap the **Vehicle** tile to view all details about your vehicle, including measurements and antenna orientation.

On the Vehicle screen, you can configure a new vehicle profile, select an existing profile, and edit profile details. New vehicle profiles with guidance will need to be calibrated from this screen.

With an appropriate and active guidance license, you can configure a vehicle to use a variety of assisted steering and full autoguidance products.

The Vehicle tile shows the currently selected vehicle. **Gray** indicates the vehicle is ready for use:



If you need to change a vehicle profile, tap the **Vehicle** tile and select a different one from the Vehicle screen. Tap **Select Vehicle**:



Allow up to 45 seconds for the vehicle profile to be updated. During this time, some functions will be disabled.

Implement

The **Implement** tile identifies the hardware you use to perform the work in the Run screen. Implements can be pull-type equipment or attachments for self-propelled equipment.

A variety of implement types is provided so that you can select the right one to accomplish your task. With an appropriate license, implements that use application control can be managed through the Precision-IQ display. With application control, you can apply just the right amount of inputs optimizing placement and application rate.

The Implement tile shows the implement type selected. **Red** indicates that an implement is invalid and requires a valid license for the application type or an update to its configuration:



You **must** select a valid implement before you can select a material or task. To change an implement profile, tap the **Implement** tile and select a different one from the Implement screen. Tap **Select Implement**:



Material

Tap the **Material** tile for details about the product you are applying to a particular field. Precision-IQ records the amount used and placement of each material.

The Material tile shows the current material selected and the coverage rate for application. **Yellow** indicates that the material must be updated:

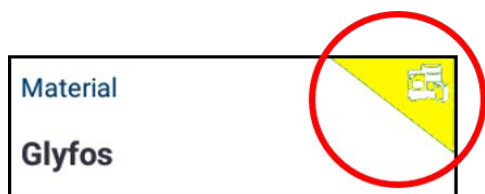

***NOTE** – If the selected implement does not apply a material (for example, tilling or subsurface drainage implements), then no material will appear on the Materials tile.*

Field

Tap the **Field** tile for a list all of the fields associated with a client and farm. Precision-IQ can manage multiple clients, farms, and fields. A client can have any number of farms, and a farm can have any number of fields. With Precision-IQ, you can quickly review all clients, farms, and fields that you need to see.

On the Fields screen, you can filter by client and farm, and you can create new ones as needed.

A newly created field **must** belong to a client and a farm.

You must select a field before you can select a task or perform any work on the Run screen. Tap the **Field** tile to select a field and filter the available fields by farm and client:

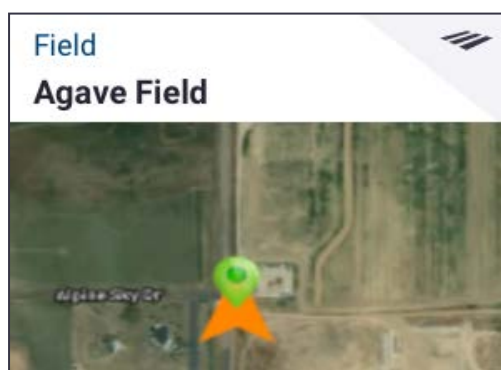

Task

The **Task** resource corresponds with the selected implement and material. The Task tile shows the percentage completed:

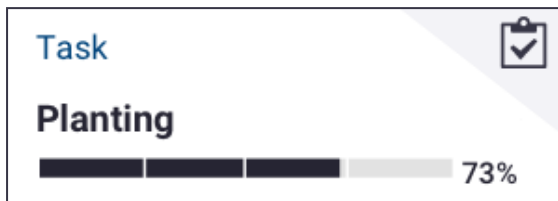

*NOTE – You **must** select a field before a task can be assigned.*

The Run Screen

With all Precision-IQ resources configured and selected, tap the green **Start** button in the upper-left corner of the screen to enter the Run screen and start your task: 

The Run screen is where you perform all field activities.

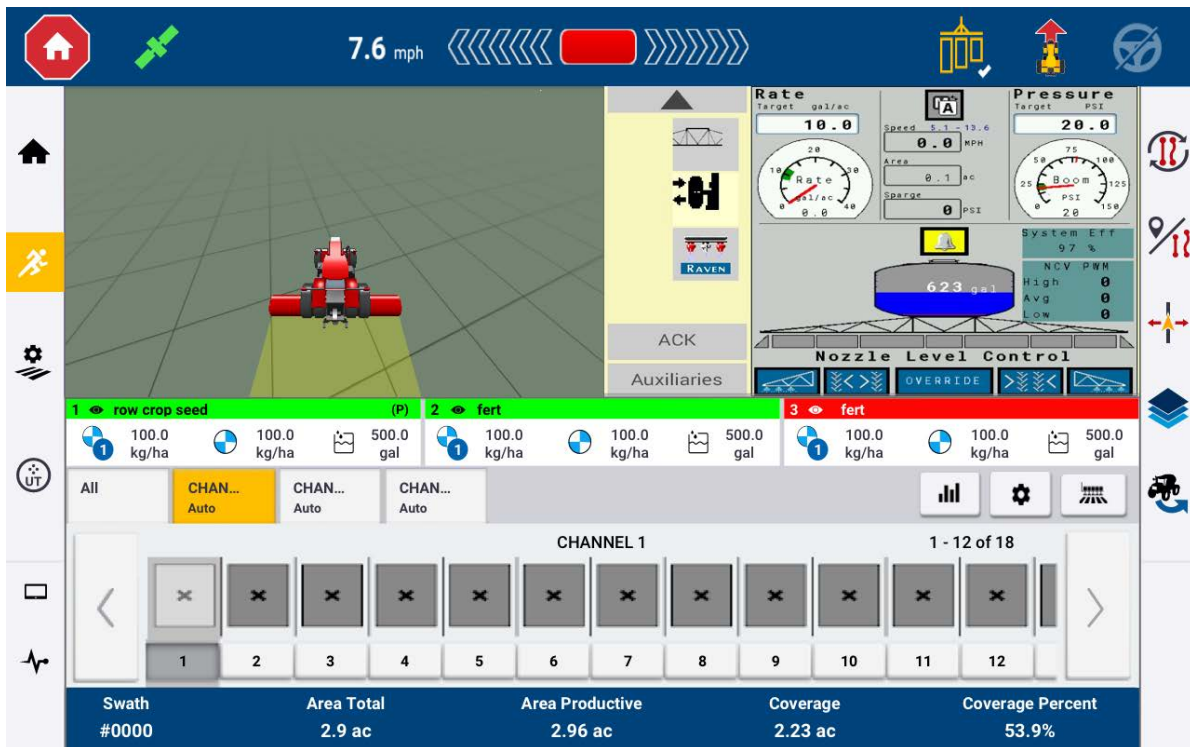

While in the Run screen, Precision-IQ records all field activity (vehicle performance, material application, field coverage, etc.). Data collected can be transferred to your office where your farm is managed.

Ending a Run

Once you have completed your field run, tap **Stop**  on the Home screen to stop the current operation task.







Run Screen Guidance Patterns

While in the Run screen, Precision-IQ records all field activity (vehicle performance, material application, field coverage, etc.).

Guidance Patterns

On the Run screen, you can define the boundaries, guidance patterns, and any number of landmarks. Tap the **Field Features** button to define the boundaries, pivots, and lines for your field:



Button	Description
	Record a Boundary for your field. This setting defines the edges of your field.
	Create a Headland for your field. Use this pattern to complete the infield and give you room to turn.
	Record a Pivot for fields that are irrigated using a center pivot.
	Create a simple AB Guidance Line when you do not need a headland and you want to drive the field in parallel straight lines.
	Create an A+ Directional Guidance Line when you need guidance exactly parallel to the last AB line.
	Record a Curved Line when you want to work the field with gentle curves.

Auto Close





For boundaries and headlands, Precision-IQ makes it easier to close the pattern with Auto Close. To use the auto close function:

1. On the Home screen, tap Settings and then tap Patterns.
2. At the Boundaries and Headlands sections, turn on auto close.







Landmarks



On the Run screen, you can define a variety of point, lines and area landmarks. Tap the **Field Features** button to define them for your field:













Button	Description
	Create a Landmark Point for your field. A Landmark Point identifies singular elements of your field to be avoided, such as a tree, rock, etc.
	Create a Landmark Line for your field. Use this line to identify continuous elements of your field to be avoided, such as a fence, ditch, access road, etc.
 	Create a Landmark Area for your field. Landmark areas are defined as: <ul style="list-style-type: none"> • <i>Productive</i>, such as a crop zone. • <i>Non-productive</i>, such as a pond, marsh, or area that does not need to be worked again.







Common Precision-IQ Icons

Activity Icons					
					
Home	Run	Field Manager	Diagnostics	Universal Terminal	Ext. Camera







Function Buttons	
	
Settings	Data Transfer

Status Buttons				
				
Start	Stop/Done	GNSS Status	Coverage Logging Active	Autosteer Ready

Run Screen Icons					
					
Nudge	Coverage Logging	Layers	Field Features	Pattern Select	Help Info

Guidance Pattern Buttons					
					
Boundary	Headland	Pivot	AB Line	A+ Line	Curve

Landmark Buttons			
			
Point	Line	Area	Nonproductive Area

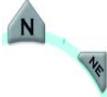
Recording Buttons							
							
Record	Set A	Set B	Complete	Pause	Cancel	Vehicle Heading	Compass Controls

Data Transfer

All data collected by Precision-IQ can be transferred to Trimble Ag Software or to other Precision-IQ displays. This data is used to efficiently and effectively manage your farm.

You can transfer this collected data:

- **Automatically** using Trimble Ag Software's AutoSync™ feature through a cellular or Wi-Fi connection.
- **Manually** using a USB drive through the USB port on the display.

For details about Trimble Ag Software or AutoSync, see:

<https://agriculture.trimble.com/software/farmers/>

Using App Central

From the Launcher screen, tap the **App Central** icon to open the App Central Marketplace. From here, you can browse available applications and updates, check licenses, and check for automatic software updates or manually update software.

On the App Central screen, tap the **menu** icon in the upper left-hand corner to display the App Central menu, where you can:

1. Tap **My Apps** to view your installed apps and to configure update notifications.
2. Tap **Browse Apps** to view all available apps that you can install.
3. Tap **Licenses** for a list of active licenses for the display and GNSS guidance controller.
4. Tap **Support** to retrieve log files to save to a USB drive. You can also send feedback to your support service and include current system information.

System Information

On the App Central screen, tap the information icon in the upper right-hand corner to display version details about your display, such as the **serial number** and **version** of Precision-IQ:

i System Information

Manufacturer: Trimble
Brand: Trimble
Model: GFX-350
Serial: 123456789
Version: 2.10.190.06.2
Time: Mar 12, 2019

**Serial Number
Precision-IQ Build Version
Number**

OK

Display Systems Supported by Precision-IQ

Precision-IQ supports the entire GFX and XCN display family.

NOTE – For details about support for the TMX-2050/XCN-2050 displays, contact your authorized reseller.

GFX-750 and XCN-1050 Displays



Item	Description	Use to...
1	Power button	Turn the display on or off.
2	Expansion Port (5-pin B code)	Connect to various inputs and outputs.
3	Main Power connector	Power the display system (including the NAV-900).
4	Power/Ethernet Port (4-pin D code)	Connect to NAV-900 Guidance controller (power/GNSS).
5	USB sockets	Connect a USB memory stick to the display to transfer data to and from the unit.
6	Power/Ethernet Port (4-pin D code)	Connect to GFX-750 (power/GNSS)
7	Main Port - 12-pin DTM	Connect to various Auto Guidance systems.
8	RTK Radio Port (5-pin A code)	Connect to various RTK radios.

⚠ CAUTION – Some connectors may appear similar, but are coded differently to ensure correct component mating. Check that you have the correct cable before connecting, and do not use excessive force or damage may result.

GFX-350 and XCN-750 Displays



Item	Description	Use to...
1	Power button	Turn the display on or off.
2	Expansion Port (5-pin B code)	Connect to various inputs and outputs.
3	Main Power connector	Power the display system (including the NAV-900).
4	Power/Ethernet Port (4-pin D code)	Connect to NAV-900 Guidance controller (power/GNSS).
5	USB sockets	Connect a USB memory stick to the display to transfer data to and from the unit.
6	Power/Ethernet Port (4-pin D code)	Connect to GFX-750 (power/GNSS)
7	Main Port - 12-pin DTM	Connect to various Auto Guidance systems.
8	RTK Radio Port (5-pin A code) (NAV-900 only)	Connect to various RTK radios.

NAV-500 Guidance Controller Installation

- ▶ [Introduction to the NAV-500 Guidance Controller](#)
- ▶ [NAV-500 Guidance Controller LED Indicators](#)
- ▶ [Mounting the NAV-500 Guidance Controller](#)
- ▶ [NAV-500 Guidance Controller Firmware](#)

This manual describes how to install the Trimble® NAV-500™ guidance controller with the GFX/XCN display family.

Even if you have used another GNSS (Global Navigation Satellite System), such as the United States' GPS (Global Positioning System), before, spend some time reading this manual to learn about the special features of this product. If you are not familiar with GNSS, go to the Trimble website (www.trimble.com) for an interactive look at Trimble and GNSS.

For additional cable guides and information on connecting Auto Guidance Systems or if you have a problem and cannot find the information you need in the product documentation, go to <https://agriculture.trimble.com/precision-ag/products/displays/> or contact Trimble technical support.

Introduction to the NAV-500 Guidance Controller

- ▶ NAV-500 Basic System Diagram
- ▶ Required Components for Mounting the NAV-500 Guidance Controller
- ▶ Preparing the Vehicle for Installation

The Trimble® GFX/XCN display is a touchscreen platform for precision agriculture. The NAV-500 guidance controller is a GNSS receiver with a basic integrated Inertial Measuring Device (IMD) and auto-guidance controller:



It has two ports on the back:

- 4-pin, D code – Power/Communication (display)
- Deutsch, 12-pin DTM – Main interface port

NAV-500 Basic System Diagram

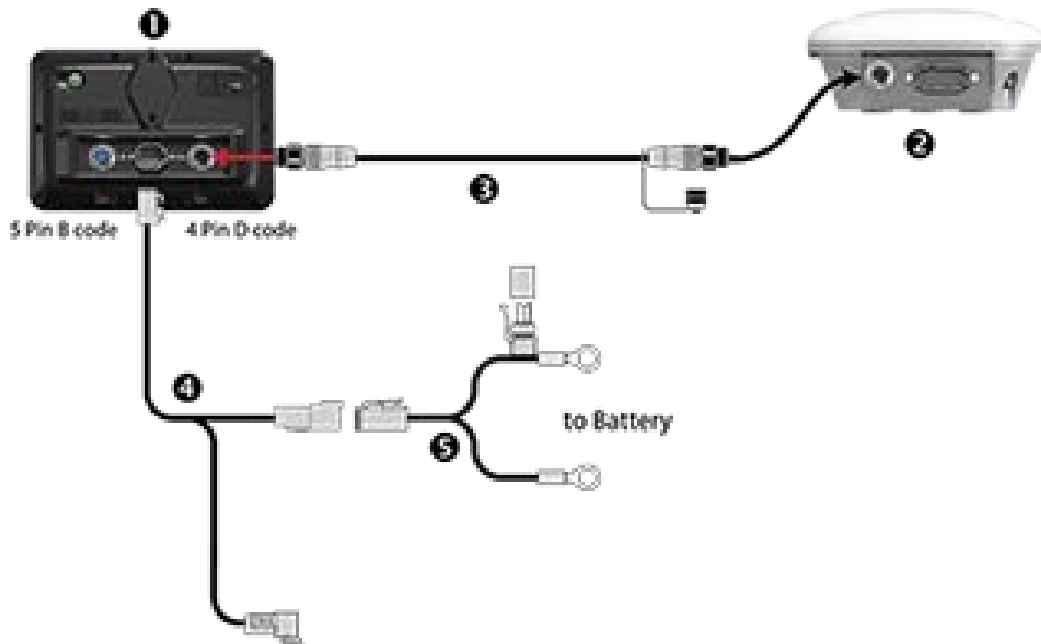

Description	P/N
1 GFX-350 Display	136000-00
2 NAV-500 Guidance Controller	132000-02
3 GFX/XCN Display to NAV-500 Guidance Controller cable	110540
4 Cable Assy, GFX/XCN, Power to display, CAN, 2.5m	110551
5 GFX-350 System Power (Battery Cable)	67258

NOTE – Cables described as for use with the GFX-750 and XCN-1050 are also applicable to the GFX-350 and XCN-750 display.

Required Components for Mounting the NAV-500 Guidance Controller

P/N	Description
132000-02	Guidance Controller, NAV-500, Trimble
118999	NAV-500, Mounting Bracket, Std.

Preparing the Vehicle for Installation

1. Park the vehicle on a hard, level surface. Block the front and rear wheels.
2. Align the steering straight ahead. On an articulated vehicle, install the articulation locks.
3. Remove all dirt and debris from the areas of the vehicle where the guidance controller will be installed.
4. Open all kit boxes and check the contents of the box against the packing list/s. Lay all of the parts out on a clean workbench.

NOTE – *The left and right sides of the vehicle are referenced while standing behind the unit, facing the normal direction of travel.*

NAV-500 Guidance Controller LED Indicators

- ▶ LED color: None
- ▶ LED color: Red
- ▶ LED color: Red/Orange
- ▶ LED color: Red/Green
- ▶ LED color: Orange
- ▶ LED color: Green
- ▶ Fatal error

On the left side of the NAV-500 is the status LED indicator with three colors: **Red**, **Orange**, and **Green**. Different modes indicate different status conditions for the receiver varying between hardware issues, firmware issues, and the GNSS fix status (varies by selected correction type).

LED color: None

LED State	Hardware/Firmware Indication	Autonomous	SBAS	ViewPoint RTX
Off	No Power	N/A	N/A	N/A

LED color: Red

LED State	Hardware/Firmware indication	Autonomous	SBAS	ViewPoint RTX
Solid	Unit has failed. Send in for service	N/A	N/A	N/A
Flashing 1 HZ	Unit is in Monitor mode. FL200 must be used to load valid main firmware	N/A	N/A	N/A
Rapid red then solid orange	Boot Monitor Activity with Main Firmware loading while unit is initializing	N/A	N/A	N/A
Alternating red and green	Firmware is uploading or Flash File system is being formatted	N/A	N/A	N/A

LED color: Red/Orange

LED State	Hardware/ Firmware Indication	Autonomous	SBAS	ViewPoint RTX
Rapid red then solid orange	Boot Monitor Activity with main firmware loading while unit is initializing	N/A	N/A	N/A

LED color: Red/Green

LED State	Hardware/Firmware Indication	Autonomous	SBAS	ViewPoint RTX
Alternating red and green	Firmware is uploading or Flash File system is being formatted	N/A	N/A	N/A

LED color: Orange

LED State	Hardware/ Firmware indication	Autonomous	SBAS	ViewPoint RTX
Rapid red then solid orange	Boot Monitor Activity with Main Firmware loading while unit is initializing	N/A	N/A	N/A
Fast flash	N/A	No position	No position	No position
Slow Flash	N/A	N/A	Autonomous No SBAS signal	Autonomous /DGPS No RTX signal
Solid	N/A	N/A	Autonomous Have SBAS signal	Autonomous /DGPS Have RTX signal

LED color: Green

LED State	Hardware/Firmware Indication	Autonomous	SBAS	ViewPoint RTX
Alternating red and green	Firmware is uploading or Flash File system is being formatted	N/A	N/A	N/A

LED State	Hardware/Firmware Indication	Autonomous	SBAS	ViewPoint RTX
Fast flash	N/A	N/A	DGPS, no SBAS signal. Using old corrections	Converged/ Unconverged. Using old corrections
Slow flash	N/A	N/A	DGPS, no SBAS signal. Using recent corrections	Unconverged
Solid	N/A	Autonomous position	DGPS, have SBAS signal	Converged

Fatal Error

A fatal error will be indicated by the following repeating cycle:

- Rapidly flashing **Red** > Solid **Orange**
- Possible flashing **Orange** > Rapidly flashing **Red**

Mounting the NAV-500 Guidance Controller

- ▶ Orientation of the Guidance Controller
- ▶ VHB (Double-Sided Tape) Style Mounting
- ▶ All mounting types – Connecting the cables

Orientation of the Guidance Controller

Mount the NAV-500 on the roof of your machine away from any obstructions that could interfere with the GNSS signal. Align the notch in the dome to the center line of the vehicle and facing forward (connectors to the rear).

Magnets will hold the controller onto the metal mounting plate that is secured with VHB tape.



VHB (Double-Sided Tape) Style Mounting

The VHB tape option is standard with the NAV-500 Mounting plate.

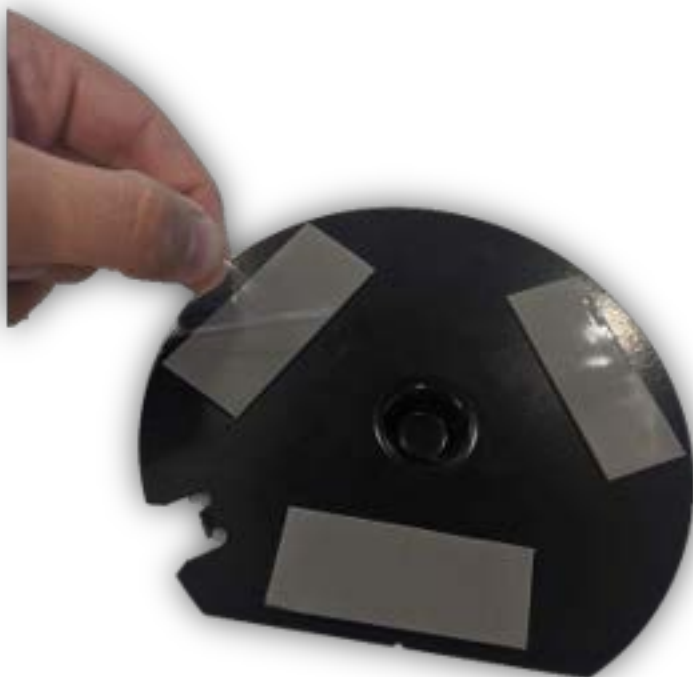

VHB tape – 3M application guidelines

- **Mating surfaces:** (tractor roof) are best prepared by cleaning with a 50:50 mixture of isopropyl alcohol (IPA) and water prior to applying 3M™ VHB™ tapes.
- **Heavy Oils:** A degreaser or solvent-based cleaner may be required to remove heavy oil or grease from a surface and should be followed by cleaning with IPA/water.
- **Temperature:** Ideal application temperature range is 70°F to 100°F (21°C to 38°C). Pressure sensitive adhesives use viscous flow to achieve substrate contact area. Minimum suggested application temperatures: 50°F (10°C).
- **Pressure:** Bond strength is dependent upon the amount of adhesive-to-surface contact developed. Firm application pressure develops better adhesive contact and helps improve bond strength. Typically, good surface contact can be attained by applying enough pressure to insure that the tape experiences approximately 15 psi (100 kPa) pressure.
- **Time:** After application, the bond strength will increase as the adhesive flows onto the surface. At room temperature approximately 50% of ultimate bond strength will be achieved after 20 minutes, 90% after 24 hours and 100% after 72 hours.
- **Disassembly and removal of residue:** To remove: If the assembled area can cope with an elevated temperature, a hand-held heat gun can soften the tape for ease of removal. Additionally, cutting through the adhesive bond-line is an effective method of

removal. Use an appropriate saw or tool. A soapy water solution can be effective to help ease of cutting. Remove adhesive residue using a 3M citrus-based cleaner, Automotive Bug and Tar remover, or other commercial adhesive removers. (Follow manufacturers instructions and safety precautions).

All mounting types – Connecting the cables

1. Connect the display cable to the 4-pin M12 connector on the left of the NAV-500 guidance controller.



2. Make sure that you align the keying and then tighten the connector.
3. If applicable, insert the install specific interface cable into the 12-pin Deutsch connector.

NAV-500 Guidance Controller Firmware

The NAV-500 firmware automatically updates to match the version running on the Trimble GFX or XCN display family.

You can get updates manually via USB drive or via the Internet using Wi-Fi.

To automatically download the latest software updates:

1. Tap **Settings** and select **WiFi Settings**.
2. Tap **Connect** to connect your display to the network of your choice.
3. On the **Android App** screen, tap **App Central** to open the App Central market place. From here, you can initialize any software notification and update.

For more information, go to <http://agpartners.trimble.com/ag-support/FirmwareMatrix/> or <https://agriculture.trimble.com/precision-ag/products/>.

Manually Installing Licenses to a NAV-500 Guidance Controller

Your authorized Trimble Reseller will provide either a USB drive or a location for you to copy a license. Save the file to the root level of a USB drive. All licenses for the NAV-500 guidance controller are installed from and managed by your GFX or XCN display. To install a license for the NAV-500 guidance controller:

1. Insert the USB drive into the GFX/XCN display.
2. On the Launcher screen, tap the **App Central** icon, then app the **Add** icon in the lower right corner:



3. Tap the **Install from USB** item:



4. In the pop-up window for your USB drive, tap the license you want to install. The license will be installed automatically.
5. Confirm that the license was installed. From the App Central menu, tap **Licenses**:



6. On the License screen, tap **NAV-500** and verify that the license has been installed:



NAV-900 Guidance Controller Installation

- ▶ [Introduction to the NAV-900 Guidance Controller](#)
- ▶ [NAV-900 Guidance Controller LED Indicators](#)
- ▶ [Mounting the NAV-900 Guidance Controller](#)
- ▶ [NAV-900 Guidance Controller Firmware](#)

This manual describes how to install the Trimble® NAV-900 guidance controller and the GFX-750 display system.

Even if you have used another GNSS (Global Navigation Satellite System), such as the United States' GPS (Global Positioning System), before, spend some time reading this manual to learn about the special features of this product. If you are not familiar with GNSS, go to the Trimble website (www.trimble.com) for an interactive look at Trimble and GNSS.

For additional cable guides and information on connecting Auto Guidance Systems or if you have a problem and cannot find the information you need in the product documentation, go to <https://agriculture.trimble.com/precision-ag/products/displays/> or contact Trimble technical support.

Introduction to the NAV-900 Guidance Controller

- ▶ NAV-900 Basic System Diagram
- ▶ Required Components for Mounting the NAV-900 Guidance Controller
- ▶ Preparing the Vehicle for Installation

The Trimble® GFX-750 display is a touchscreen platform for precision agriculture.

The NAV-900 guidance controller is a GNSS receiver with an integrated Inertial Measuring Device (IMD) and auto-guidance controller:



It has three ports on the back:

- 4-pin, D code – Power/Communication (display) 1
- Deutsch, 12-pin DTM – Main interface port 2
- 5-pin, A code – RTK Radio connection 3

NAV-900 Basic System Diagram

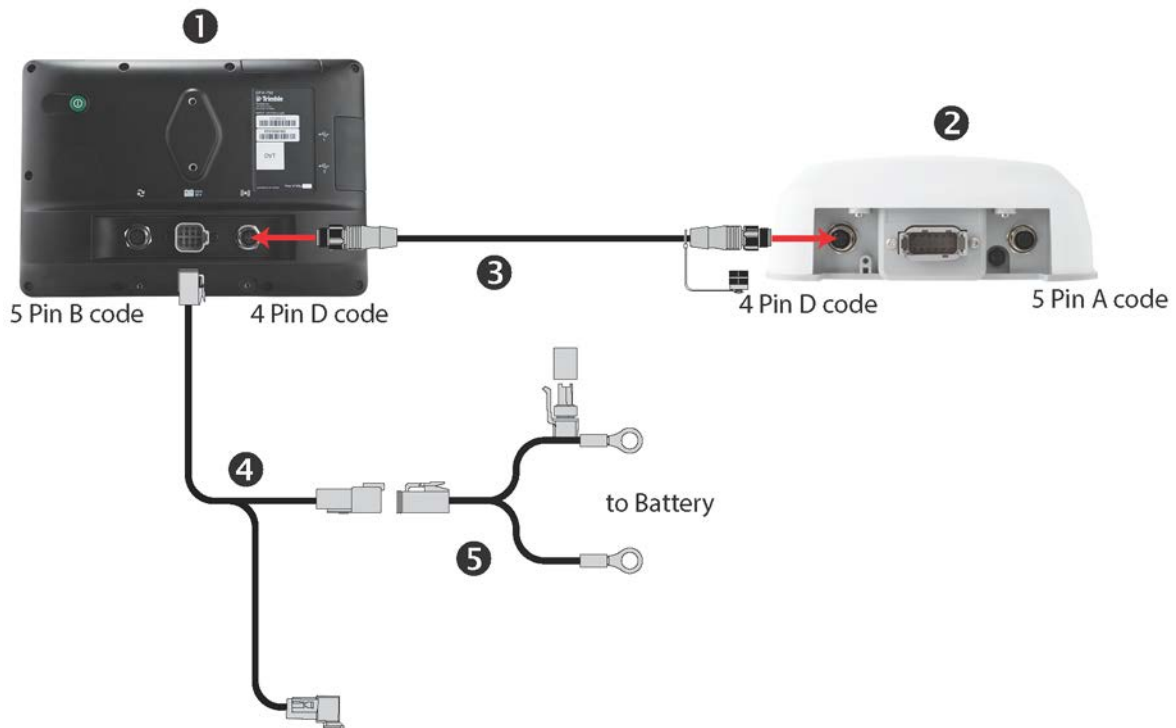

Description	P/N
1 GFX-750 Display	121000-05
2 GFX-750 Display to NAV-900 Guidance Controller cable	110540
3 NAV-900 Guidance Controller	108993-05
4 GFX-750 System Power and CAN (1) display cable. CAN Port - Uses adapters to connect to CAN implement devices (ISO and Field-IQ™ Basic)	110551
5 GFX-750 System Power (Battery Cable)	67258

Required Components for Mounting the NAV-900 Guidance Controller

P/N	Description
108993-05	Guidance Controller, NAV-900, Trimble
109315	NAV-900 Base Mount Plate
109890	NAV-900 Base Mount Feet

Optional Accessories for Mounting

P/N	Description
109314	NAV-900, Mount, Quick Release Kit
110308	NAV-900, Mount, Spar Quick Release Adapter
111339	NAV-900, Mount, CNH Quick Release Adapter
111340	NAV-900, Mount, Agco Adapter
111342	NAV-900, Mount, JD Adapter
64898	Spar mount: 16.5" – 28.5"
55349	Spar mount: 27.5" – 37.5"
53676	Spar mount: 36.5" – 46.5"
55348	Spar mount: 45" - 55"
66774	Spar mount: 54" – 64"

NOTE – The standard multi-purpose mount plate and feet are supplied in your basic kit. Optional vehicle specific mounts are also available including the ones shown in the above table.

Ag-820 Radio System

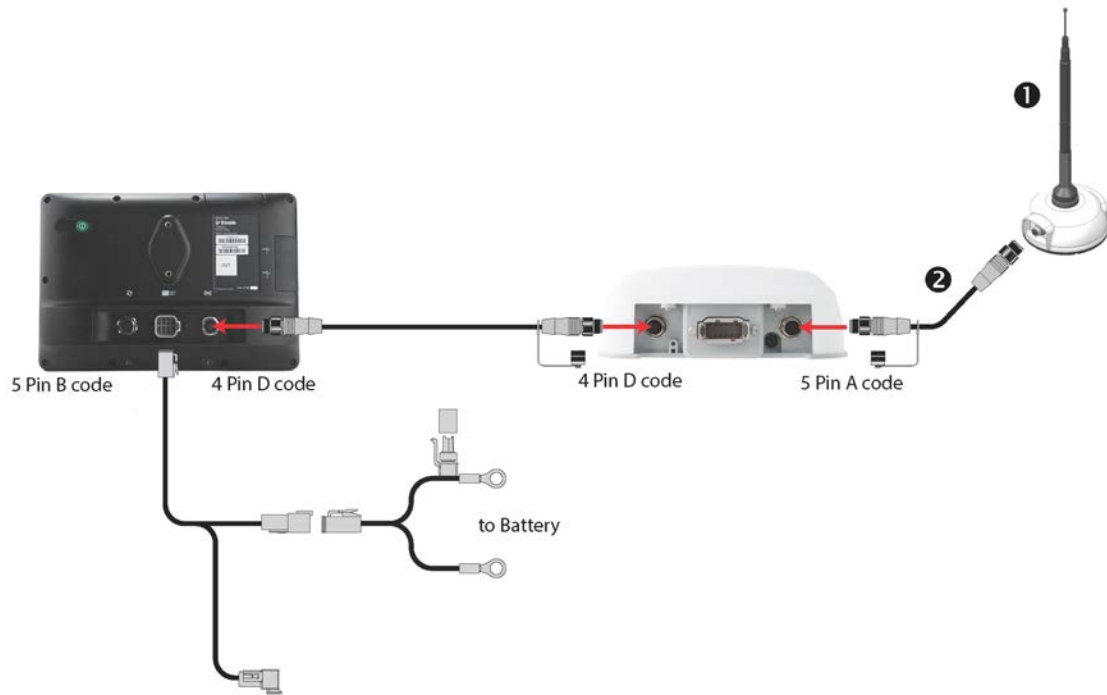

Description	P/N
① Ag-820 Radio Kit, 430-450 MHz	123500-44
Ag-820 Radio Kit, 450-470 MHz	123500-46
Ag-820 Radio Kit, 900 MHz	123500-90
② NAV-900 to Ag-820 cable	113295

Preparing the Vehicle for Installation

1. Park the vehicle on a hard, level surface. Block the front and rear wheels.
2. Align the steering straight ahead. On an articulated vehicle, install the articulation locks.
3. Remove all dirt and debris from the areas of the vehicle where the guidance controller will be installed.
4. Open all kit boxes and check the contents of the box against the packing list/s. Lay all of the parts out on a clean workbench.

NOTE – *The left and right sides of the vehicle are referenced while standing behind the unit, facing the normal direction of travel.*

NAV-900 Guidance Controller LED Indicators

- ▶ LED color: None
- ▶ LED color: Red
- ▶ LED color: Red/Orange
- ▶ LED color: Red/Green
- ▶ LED color: Orange
- ▶ LED color: Green
- ▶ Fatal error

Below the M12 4-pin display connector is the status LED indicator with three colors: **Red**, **Orange**, and **Green**. Different modes indicate different status conditions for the receiver varying between hardware issues, firmware issues, and the GNSS fix status (varies by selected correction type).

LED color: None

LED State	Hardware/ Firmware indication	Autonomous	SBAS	Rangepoint RTX	OmniSTAR HP/XP/G2	CenterPoint RTX (FS/SS)	CenterPoint RTX (Cell)	CenterPoint RTK/VRS
Off	No Power	N/A	N/A	N/A	N/A	N/A	N/A	N/A

LED color: Red

LED State	Hardware/ Firmware indication	Autonomous	SBAS	Rangepoint RTX	OmniSTAR HP/XP/G2	CenterPoint RTX (FS/SS)	CenterPoint RTX (Cell)	CenterPoint RTK/VRS
Solid	Unit has failed. Send in for service	N/A	N/A	N/A	N/A	N/A	N/A	N/A
Flashing 1 HZ	Unit is in Monitor mode. FL200 must be used to load valid main firmware	N/A	N/A	N/A	N/A	N/A	N/A	N/A
Rapid red then solid orange	Boot Monitor Activity with Main Firmware loading while unit is initializing	N/A	N/A	N/A	N/A	N/A	N/A	N/A
Alternating red and green	Firmware is uploading or Flash File system is being formatted	N/A	N/A	N/A	N/A	N/A	N/A	N/A

LED color: Red/Orange

LED State	Hardware/ Firmware indication	Autonomous	SBAS	Rangepoint RTX	OmniSTAR HP/XP/G2	CenterPoint RTX (FS/SS)	CenterPoint RTX (Cell)	CenterPoint RTK/VRS
Rapid red then solid orange	Boot Monitor Activity with main firmware loading while unit is initializing	N/A	N/A	N/A	N/A	N/A	N/A	N/A

LED color: Red/Green

LED State	Hardware/ Firmware indication	Autonomous	SBAS	Rangepoint RTX	OmniSTAR HP/XP/G2	CenterPoint RTX (FS/SS)	CenterPoint RTX (Cell)	CenterPoint RTK/VRS
Alternating red and green	Firmware is uploading or Flash File system is being formatted	N/A	N/A	N/A	N/A	N/A	N/A	N/A

LED color: Orange

LED State	Hardware/ Firmware indication	Autonomous	SBAS	Rangepoint RTX	OmniSTAR HP/XP/G2	CenterPoint RTX (FS/SS)	CenterPoint RTX (Cell)	CenterPoint RTK/VRS
Rapid red then solid orange	Boot Monitor Activity with Main Firmware loading while unit is initializing	N/A	N/A	N/A	N/A	N/A	N/A	N/A
Fast flash	N/A	No position	No position	No position	No position	No position	No position	No position
Slow Flash	N/A	N/A	Autonomous No SBAS signal	Autonomous /DGPS No RTX signal	Autonomous /DGPS No OmniSTAR signal	Autonomous /DGPS No RTX signal	Autonomous /DGPS Not connected to RTX server	Autonomous /DGPS No CMR or RTCM3 corrections
Solid	N/A	N/A	Autonomous Have SBAS signal	Autonomous /DGPS Have RTX signal	Autonomous /DGPS Have OmniSTAR signal	Autonomous /DGPS Have RTX signal	Autonomous /DGPS. Connected to RTX server	Autonomous /DGPS CMR or RTCM3 corrections arriving

LED color: Green

LED State	Hardware/ Firmware indication	Autonomous	SBAS	Rangepoint RTX	OmniSTAR HP/XP/G2	CenterPoint RTX (FS/SS)	CenterPoint RTX (Cell)	CenterPoint RTK/VRS
Alternating red and green	Firmware is uploading or Flash File system is being formatted	N/A	N/A	N/A	N/A	N/A	N/A	N/A

LED State	Hardware/ Firmware indication	Autonomous	SBAS	Rangepoint RTX	OmniSTAR HP/XP/G2	CenterPoint RTX (FS/SS)	CenterPoint RTX (Cell)	CenterPoint RTX/VRS
Fast flash	N/A	N/A	DGPS, no SBAS signal. Using old corrections	Converged/ Unconverged. Using old corrections	Subscription expired or other error	Converged/ Unconverged. Using old corrections	Converged/ Unconverged. Using old corrections	Fixed/Float. Using old corrections
Slow flash	N/A	N/A	DGPS, no SBAS signal. Using recent corrections	Unconverged	Unconverged	Unconverged	Unconverged	Float
Solid	N/A	Autonomous position	DGPS, have SBAS signal	Converged	Converged	Converged	Converged	Fixed

Fatal error

A fatal error will be indicated by the following repeating cycle:

- Rapidly flashing **Red** > Solid **Orange**
- Possible flashing **Orange** > Rapidly flashing **Red**

Mounting the NAV-900 Guidance Controller

- ▶ Orientation of the Guidance Controller
- ▶ NAV-900 Guidance Controller Mounting Options
- ▶ Attaching the Base Mounting Plate
- ▶ Factory-Fitted Specific Mounting Options
- ▶ Spar Mounting Method
- ▶ All mounting types – Connecting the cables

Orientation of the Guidance Controller

The presence of the Inertial Measurement Device (IMD) requires that the device is installed rigidly with the orientation of the guidance controller being specified in reference to the top/front of the vehicle.

A neutral 0°, 0°, 0° (Roll, Pitch, Yaw) orientation is required, with the dome up and the connectors facing backwards toward the rear of the tractor.

NAV-900 Guidance Controller Mounting Options

1. VHB (Double-Sided Tape) Style Mounting.

***NOTE** – VHB mounting is not recommended for high-precision auto guidance installations and should be used as the last option; a more rigid fixed mount option is recommended as some cabs can have flexibility in their structure. For high performance, choose from one of our more rigid factory mount adapters or spar mount options. See [Optional Accessories for Mounting](#).*

2. Factory-fitted mounts:

- AGCO Factory Roof Mounts
 - Challenger
 - Massey Ferguson
 - Valtra
- Case IH Factory Roof Mounts
- Fendt Internal Roof Factory Mounts
- John Deere Starfire Factory Mounts
- New Holland Factory Roof Mounts

3. Spar Mounting Method

Attaching the Base Mounting Plate

The guidance controller has a base mounting plate (P/N 109315) for adapting to other mounting fixtures. It is attached using four M6 x 14 mm bolts with flat washers and lock washers into the 4 bolts in the base of the housing. Tighten the four M6 fasteners to 7.0 ± 0.4 ft-lbs (10.0 ± 0.5 N-m).



VHB (Double-Sided Tape) Style Mounting

The VHB tape option is standard with some display system kits and can be used if no factory-fitted mount or Spar mount option is available.

VHB tape – 3M application guidelines

- **Mating surfaces:** (tractor roof) are best prepared by cleaning with a 50:50 mixture of isopropyl alcohol (IPA) and water prior to applying 3M™ VHB™ tapes.

- **Heavy Oils:** A degreaser or solvent-based cleaner may be required to remove heavy oil or grease from a surface and should be followed by cleaning with IPA/water.
- **Temperature:** Ideal application temperature range is 70°F to 100°F (21°C to 38°C). Pressure sensitive adhesives use viscous flow to achieve substrate contact area. Minimum suggested application temperatures: 50°F (10°C).
- **Pressure:** Bond strength is dependent upon the amount of adhesive-to-surface contact developed. Firm application pressure develops better adhesive contact and helps improve bond strength. Typically, good surface contact can be attained by applying enough pressure to insure that the tape experiences approximately 15 psi (100 kPa) pressure.
- **Time:** After application, the bond strength will increase as the adhesive flows onto the surface. At room temperature approximately 50% of ultimate bond strength will be achieved after 20 minutes, 90% after 24 hours and 100% after 72 hours.
- **Disassembly and removal of residue:** To remove: If the assembled area can cope with an elevated temperature, a hand-held heat gun can soften the tape for ease of removal. Additionally, cutting through the adhesive bond-line is an effective method of removal. Use an appropriate saw or tool. A soapy water solution can be effective to help ease of cutting. Remove adhesive residue using a 3M citrus-based cleaner, Automotive Bug and Tar remover, or other commercial adhesive removers. (Follow manufacturers instructions and safety precautions).

1. Start by putting the height adjustment nuts on the VBH plate stud.



2. Insert the stud through one of the three outer mounting holes on the main mounting plate.



3. Place the flat washer and lock washer on the stud. Loosely thread the remaining nut onto the stud.



4. Repeat for the other two stud mounts.



5. Attach the guidance controller to the main mounting plate.
6. Verify the vehicle is sitting in a level location.
7. Find a suitable location on the top of the tractor cab with minimal flex and height variation.
8. Before removing the VHB protective covers, place and mark the location on the cab ensuring it is on the center-line of the vehicle. Mark each VHB foot.

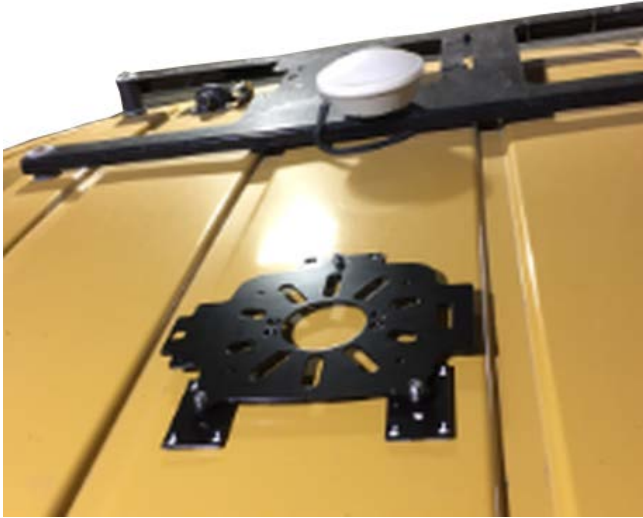

9. Peel the covers from the VHB tape and place the feet in the marked locations.
10. Adjust the height of the nuts on the studs to level the guidance controller.

Factory-Fitted Specific Mounting Options

AGCO Factory Roof Mounts

There are five (5) different types available.

Example - AGCO Challenger MT 765E Tracked Tractor

1. Fit the two tabs on the NAV-900 guidance controller mount plate into the slots on the existing roof bracket.

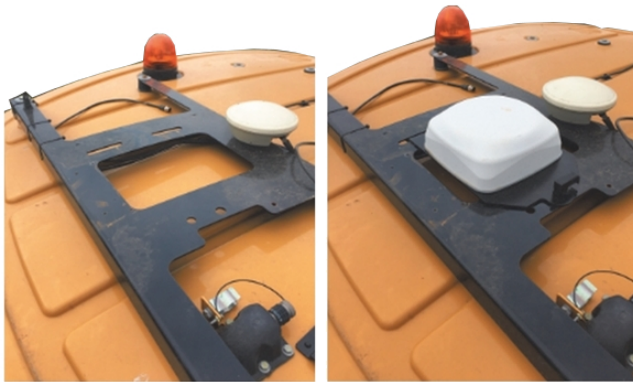

2. Insert, twist, and latch the opposite side of the plate.



Case IH Factory Roof Mounts

Case IH machines that come factory ready are fitted with a quick release mount for the 252/262/372 receivers. There is a specific NAV-900 guidance controller mount plate for these vehicles (P/N 111339).

Slip the open slot on the mount plate over the raised tab on the CNH receiver mount plate and then use the over-center latch to secure the guidance controller.

Case IH Flagship combine install: (Case IH 9120 pictured)

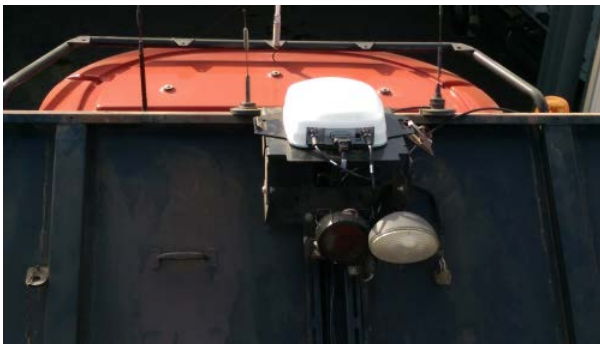
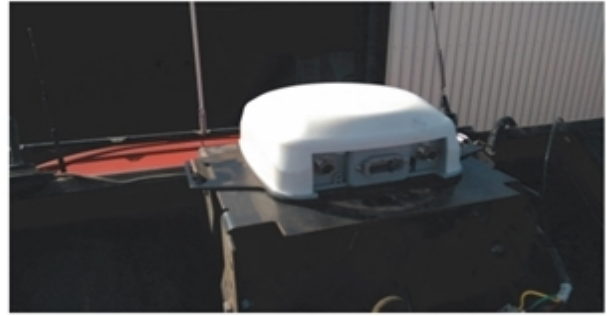
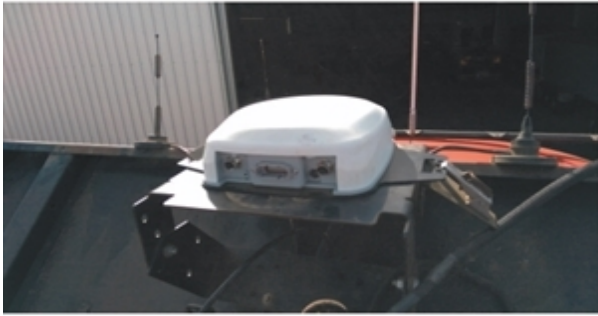

Case IH Tractor install: (CIH Magnum 340 pictured)



Fendt Internal Roof Factory Mounts

Guidance Ready Fendt (MY 2016 and later) and Challenger 1000 series machines have a cavity within the roof for GNSS antennas.

For these machines: (Fendt 716 Vario Profi MY2016 shown)

1. Open the roof cavity.

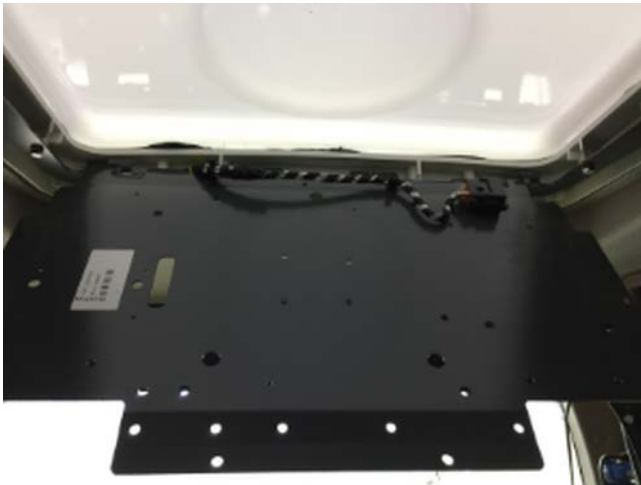

2. Remove the antenna mounting tray. Center the guidance controller on the tray.



3. Use the base mounting plate as a template to mark and drill $\frac{1}{4}$ " holes for mounting the guidance controller.



4. Re-insert the mounting tray in the roof, and use the M6 bolts.

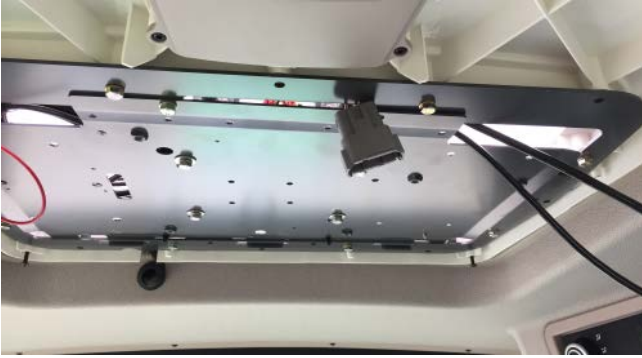

John Deere Starfire Factory Mounts

Current versions

1. Secure the guidance controller to the John Deere factory adapter (P/N 111342) using the four supplied countersunk M6 bolts. The connectors should be located opposite of the latch.





The adapter will secure to the John Deere factory Mounting Square:



2. Lay the back side of the mount onto the square.



3. Lay the front side down and secure with the latch.



4. Connect the Interface Cable to the Starfire connector under the front of the roof.

New Holland Factory Roof Mounts

New Holland machines that come factory ready are fitted with a quick release mount for the 252/262/372 receivers. The NAV-900 guidance controller CNH adapter plate (P/N 111339) will fit into these mounts.

See also [Case IH Factory Roof Mounts](#).

Spar Mounting Method

For vehicles that do not have factory mounting methods or the factory mounting method is already in use, Spar mounts are available to span between rigid bolts on the roof.

Lengths available are:

- P/N 64898: 16.5" – 28.5"
- P/N 55349: 27.5" – 37.5"
- P/N 53676: 36.5" – 46.5"
- P/N 55348: 45" - 55"
- P/N 66774: 54" – 64"

The guidance controller plate has a four-bolt pattern that directly attaches to the spar mounts:



1. Remove the spar from the box and lay out the hardware:



2. Align the four holes on the base mounting plate with the four holes in the spar. Install the supplied $\frac{1}{4}$ -20 \times $\frac{1}{2}$ " countersunk bolts and tighten appropriately.

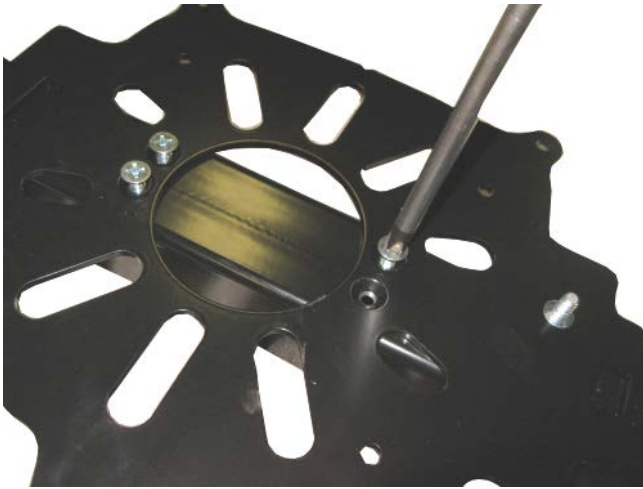

3. Lay the guidance controller on its top.



4. Lay the mounting plate with spar attached over on top. Attach the plate to the guidance controller with the four 6 mm bolts and lock washers. Tighten the bolts. Take care not to over-tighten the bolts as damage may result.



5. Loosen and remove the large bolts on the cab that are to be used to fasten down the spar.



6. Place the supplied spacer on the cab mounting point. The thickness of the spacer will vary by kit.



7. Locate the provided longer bolts to be use for securing the spar. Put both the original washer and the larger provided washer on the bolt.



8. Place the spar on the space and insert the bolt.



9. Insert the bolt on the other side of the cab. Center the spar on the cab using a measuring tape. Then tighten the bolts.



All mounting types – Connecting the cables

1. Connect the display cable to the 4-pin M12 connector on the left of the NAV-900 guidance controller.



2. Make sure that you align the keying and then tighten the connector.
3. Insert the install specific interface cable into the 12-pin Deutsch connector.
4. If a radio is being installed, remove the plastic cap on the radio connector (right side 5-pin M12 connector) and carefully align the keying. Tighten the connector.
5. If no radio is being installed, leave the cap on for weather protection.

NAV-900 Guidance Controller Firmware

The NAV-900 firmware automatically updates to match the version running on the Trimble GFX or XCN display family.

You can get updates manually via USB drive or via the Internet using Wi-Fi.

To automatically download the latest software updates:

1. Tap **Settings** and select **WiFi Settings**.
2. Tap **Connect** to connect your display to the network of your choice.
3. On the **Android App** screen, tap **App Central** to open the App Central market place. From here, you can initialize any software notification and update.

For more information, go to <http://agpartners.trimble.com/ag-support/FirmwareMatrix/> or <https://agriculture.trimble.com/precision-ag/products/>.

Manually Installing Licenses to a NAV-900 Guidance Controller

Your authorized Trimble Reseller will provide either a USB drive or a location for you to copy a license. Save the file to the root level of a USB drive. All licenses for the NAV-900 guidance controller are installed from and managed by your GFX or XCN display. To install a license for the NAV-900 guidance controller:

1. Insert the USB drive into the GFX/XCN display.
2. On the Launcher screen, tap the **App Central** icon, then tap the **Add** icon in the lower right corner:



3. Tap the **Install from USB** item:

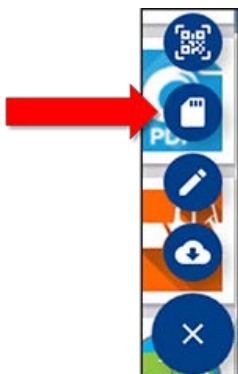

4. In the pop-up window for your USB drive, tap the license you want to install. The license will be installed automatically.

5. Confirm that the license was installed. From the App Central menu, tap **Licenses**:



6. On the License screen, tap **NAV-900** and verify that the license has been installed:

