

# GFX/XCN Display Series

## USER GUIDE

**NOTE** – This document provides details for the GFX-350 and XCN-750 (124000-99), GFX-1060 and XCN-1060 (134000-99), and GFX-1260 and XCN-1260 (137000-99) displays. For complete details, contact your authorized reseller.

Version 3.00  
Revision A  
September 2022

### Corporate Office

10368 Westmoor Drive  
Westminster, CO 80021  
USA

### Agriculture Business Area

Trimble Inc.  
Trimble Agriculture Division  
10368 Westmoor Drive  
Westminster, CO 80021  
USA  
trimble\_support@trimble.com  
[www.trimble.com](http://www.trimble.com)

### Legal Notices

© 2022, Trimble Inc. All rights reserved.

Trimble, the Globe & Triangle logo are trademarks of Trimble Inc, registered in the United States and in other countries.

Precision-IQ and NAV-500 are trademarks of Trimble Inc.

All other trademarks are the property of their respective owners.

### Release Notice

This is the September2022 release (Revision A) of the GFX/XCN Display Series User Guide.

# Safety Information

Always follow the instructions that accompany a Warning or Caution. The information they provide is intended to minimize the risk of personal injury and/or damage to property. In particular, observe safety instructions that are presented in the following format:

**WARNING** – This alert warns of a potential hazard which, if not avoided, could result in severe injury or even death.

**CAUTION** – This alert warns of a potential hazard or unsafe practice which, if not avoided, could result in injury or property damage or irretrievable data loss.

**NOTE** – An absence of specific alerts does not mean that there are no safety risks involved.

## Warnings

**WARNING** – When you are working on the vehicle's hydraulic systems, vehicle attachments that are suspended can drop. If you are working around the vehicle, you could suffer serious injury if an attachment dropped on you. To avoid this risk, lower all vehicle attachments to the ground before you begin work.

**WARNING** – If someone else attempts to drive the vehicle while you are working on or under it, you can suffer serious or fatal injuries. To avoid this possibility, install a lockout box on the battery terminal to prevent the battery from being reconnected, remove the key from the vehicle's ignition switch, and attach a "Do not operate" tag in the cab.

**WARNING** – Agricultural chemicals can pose serious health risks. If the vehicle has been used to apply agricultural chemicals, steam clean the vehicle to remove any chemical residue from the areas of the vehicle where you will be working.

**WARNING** – Vehicle cabs can be quite high in the air. To avoid potentially serious injury through falling from this height, always use the steps and handrails, and face the vehicle, when you enter or exit it.

**WARNING** – Vehicles must be parked on a hard, level surface with the front and rear wheels blocked. The steering must be aligned straight ahead. For articulated vehicles, articulation locks must be installed.

## Cautions

**CAUTION** – When the vehicle has been running, parts of the vehicle, including the engine and exhaust, can become extremely hot and can cause serious burns. To avoid burns, allow hot machine parts to cool before you begin working on them.

**CAUTION** – The system installation may bring you into contact with chemical substances, such as oil, which can cause poisoning. Wash your hands thoroughly after you finish working on the system.

**CAUTION** – Battery posts, terminals, and related accessories contain lead and lead compounds, which can cause serious illness. To avoid ingesting lead, wash your hands thoroughly after touching the battery. Take care not to short-circuit the battery with tools and/or by the incorrect fitting of cables as fire, burns, and damage can occur.

**CAUTION** – Always wear protective equipment appropriate to the job conditions and the nature of the vehicle. This includes wearing protective glasses when you use pressurized air or water, and correct protective welder's clothing when welding. Avoid wearing loose clothing or jewelry that can catch on machine parts or tools.

**CAUTION** – Parts of the vehicle may be under pressure. To avoid injury from pressurized parts, relieve all pressure in oil, air, and water systems before you disconnect any lines, fittings, or related items. To avoid being sprayed by pressurized liquids, hold a rag over fill caps, breathers, or hose connections when you remove them. Do not use your bare hands to check for hydraulic leaks. Use a board or cardboard instead.

**CAUTION -**

Do not direct pressurized water at:

- electronic or electrical components or connectors
- bearings
- hydraulic seals
- fuel injection pumps
- any other sensitive parts or components



Set the hose pressure as low as practicable, and spray at a 45° to 90° angle. Keep the nozzle of the power washer away from the machine at the distance recommended by the manufacturer.

**CAUTION -** To prevent damage to the system, make sure that no wires or hoses interfere with or catch on any mechanical linkages, or contact any machine parts that get hot.

# Contents

<b>Safety Information</b> .....	<b>i</b>
Warnings .....	i
Cautions .....	ii
<b>Display Overview</b> .....	<b>1</b>
Introduction to the GFX/XCN Displays .....	2
Display Rear View Connectors .....	3
Expansion Ports .....	3
GNSS Guidance Controller Overview .....	4
GNSS Guidance Controller Review View Connector .....	5
Connecting a Display to the GNSS Guidance Controller .....	6
<b>App Central Overview</b> .....	<b>7</b>
App Central Marketplace .....	8
System Information .....	8
Managing Licenses .....	9
Install a License from a USB Drive .....	10
Scan a QR Code to Install a License .....	11
<b>Precision-IQ Overview</b> .....	<b>12</b>
Precision-IQ Home Screen and Run Screen Overview .....	13
Precision-IQ Home Screen Overview .....	13
Precision-IQ Run Screen Overview .....	14
Common Icons in Precision-IQ .....	16
Precision-IQ Home Screen Icons .....	16
Precision-IQ Run Screen Icons .....	18
Set Up and Select Precision-IQ Resources .....	22
Resource Tile Overview .....	22
Resource Tile Color Codes .....	23
Create a Resource Profile .....	24
Select a Resource Profile .....	25
Copy an Existing Resource Profile .....	25
Licensed Features .....	26
Operator Login and Permissions .....	27
Trimble Ag Software: Operator Permissions Setup .....	27
Trimble Ag Software Mobile App: Operator Permissions Setup .....	29

Login to a Precision-IQ Display .....	30
<b>System Settings .....</b>	<b>31</b>
Android Settings .....	32
Precision-IQ Settings .....	34
Precision-IQ Setting Examples .....	34
<b>Data Transfer .....</b>	<b>37</b>
Data Transfer Overview .....	38
AutoSync Overview .....	38
Setup and Configuration for Wireless Data Transfer .....	40
Configuring FarmStream Settings .....	40
Using Data Transfer Wirelessly .....	44
Transferring Data Wirelessly to the Display Using Trimble Ag Desktop Software .....	44
Using Data Transfer Manually .....	45
USB VDB Transfer .....	45
Data Transfer Between Precision-IQ Displays .....	46
Export Precision-IQ Resources to a USB Drive .....	46
Import Resources to a Precision-IQ Display .....	47
Supported Data Transfer Functions .....	47
Delete a Precision-IQ Resource .....	48
<b>Auxiliary Attachments .....</b>	<b>49</b>
External Camera .....	50
Cables .....	51

# Display Overview

- ▶ Introduction to the GFX/XCN Displays
- ▶ Display Rear View Connectors
- ▶ GNSS Guidance Controller Overview
- ▶ GNSS Guidance Controller Review View Connector
- ▶ Connecting a Display to the GNSS Guidance Controller



## Introduction to the GFX/XCN Displays

The GFX/XCN series of displays were designed and developed to work in the most rugged of farm environments. With sizes starting at 7 inches (17.8 cm) and larger, each display includes built-in Wi-Fi and Bluetooth® support and provides the operator with an extensive view of any field task.

GFX/XCN 7-Inch Display  
(17.8 cm)



GFX/XCN 10-Inch Display  
(25.4 cm)



Paired with either the NAV-900 or NAV-500™ GNSS guidance controller, a complete precision agriculture experience awaits you!

NAV-900 Guidance Controller









NAV-500 Guidance Controller

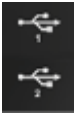

## Display Rear View Connectors



	Connector	Description		Connector	Description
1	<b>Power button</b> 	Turn the display on or off.	4	<b>Expansion Port 2</b> M16 8-pin 	Connect to various inputs and outputs <i>Port not available on some models.</i>
2	<b>USB port(s)</b> 7-inch display: 1 port only 	Connect a USB drive to transfer data to/from the display.	5	<b>Power connector</b> 	Connect to power source. This connection also provides CAN communication, ignition sense in, and relay out control.
3	<b>Expansion Port 1</b> M12 5-pin 	Connect to various inputs and outputs	6	<b>Ethernet port/ power out</b> 	Connect to and power GNSS guidance controller (GNSS-1).

### Expansion Ports

All displays include at least one 5-pin expansion port. This port with proper cabling can be used to connect an analog camera (for PAL or NTSC video).

### Analog Ag Camera



**NOTE** - Additional connection cables are required.

The 10-inch and 12-inch displays are available with an additional 8-pin expansion port.

#### 5-Pin Expansion Port



#### 8-Pin Expansion Port



**CAUTION** - Before connecting any external device, verify the connector compatibility.

## GNSS Guidance Controller Overview

The GFX/XCN Display Series support both NAV-500™ and NAV-900 guidance controllers.

### NAV-900 Guidance Controller



### NAV-500 Guidance Controller



### NAV-900 Guidance Controller (rear view)





### NAV-500 Guidance Controller (rear view)

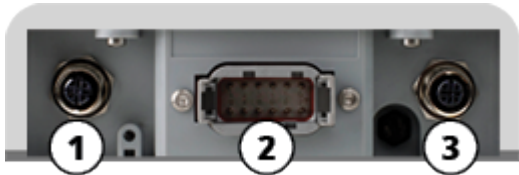

# GNSS Guidance Controller Review View Connector



	Connector	Description
1	<b>Ethernet port/power in</b> <i>(4-pin D code)</i> 	Connect to and receive power from the display.
2	<b>Main port</b> <i>(12-pin DTM)</i> 	Connect to various auto guidance systems.
3	<b>Radio port</b> <i>(5-pin A code)</i>  <b>NAV-900 only</b>	Connects to an RTK radio or a non-Wi-Fi modem.

# Connecting a Display to the GNSS Guidance Controller

**CAUTION** - Some connectors may appear similar, but are coded differently to ensure correct component mating. Check that you have the correct cable before connecting, and do not use excessive force or damage may result.

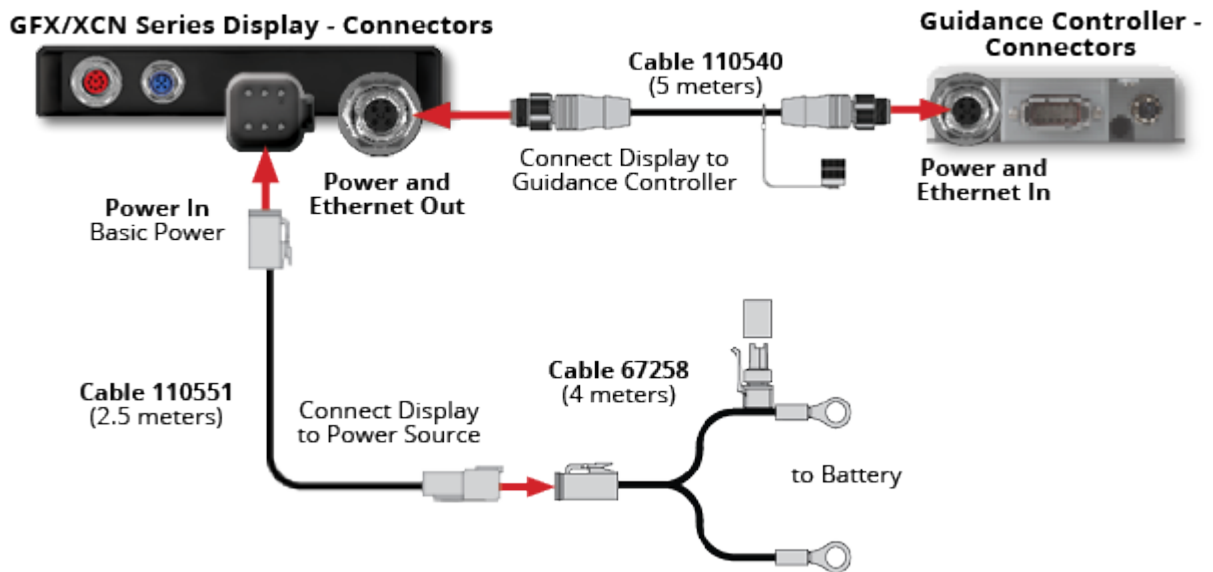

# App Central Overview

- ▶ App Central Marketplace
- ▶ System Information
- ▶ Managing Licenses

From the Launcher screen, tap the **App Central** icon to open the App Central Marketplace:



**NOTE** – If the App Central icon is not on the Launcher screen, find it under Android's **All Apps**. Tap and drag the **App Central** icon onto the Launcher screen.

## App Central Marketplace

App Central includes a variety of tested, third-party apps you may find useful for your farm. From the Launcher screen, tap the **App Central** icon to open the App Central Marketplace:

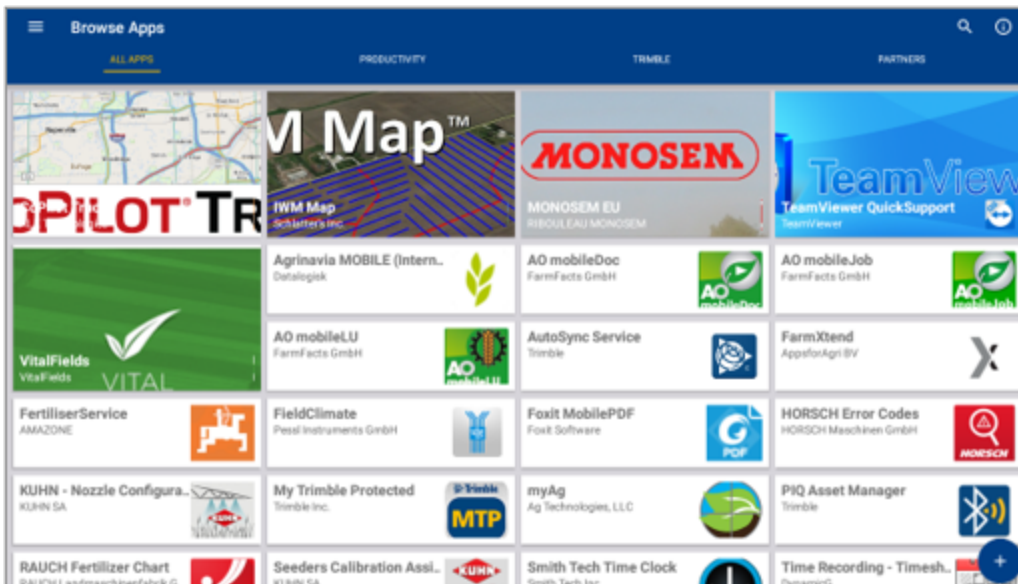

- **Browse Apps:** shows when there is a connection to the Internet.
- **My Apps:** shows when there is not a connection to the Internet.

A menu item allows you to select between My Apps and Browse Apps.

## System Information

Tap the **System Information** icon to view details about your display, including manufacturer, serial number, and installed firmware version:

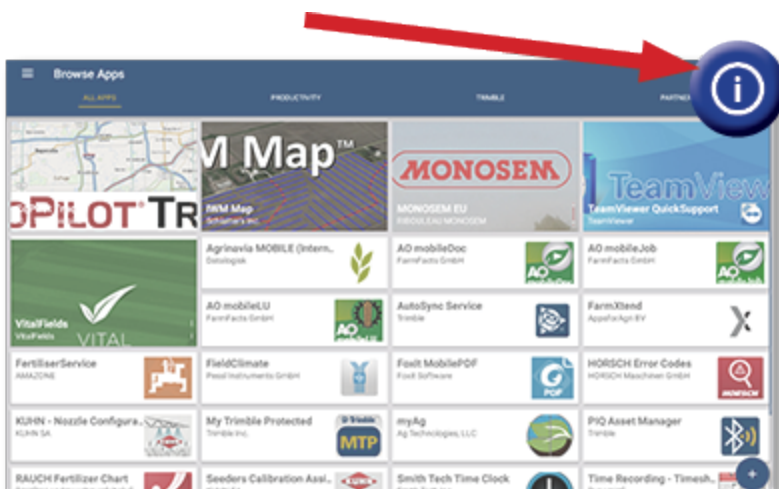

# Managing Licenses

Any license purchased, downloaded, and installed onto the display or GNSS controller is managed through App Central. Tap the hamburger menu icon to open the App Central menu:



Select **Licenses** and the device you want to review to browse active licenses, view license start/expiration dates, and manually apply a license:

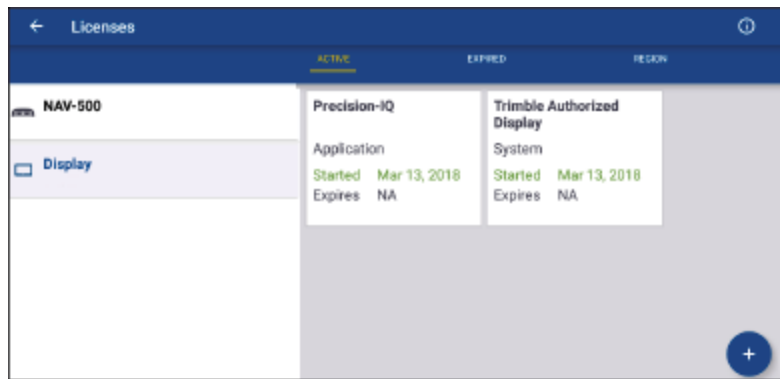

As your requirements change, you can add features and functionality to Precision-IQ. Each license applied is shown here:

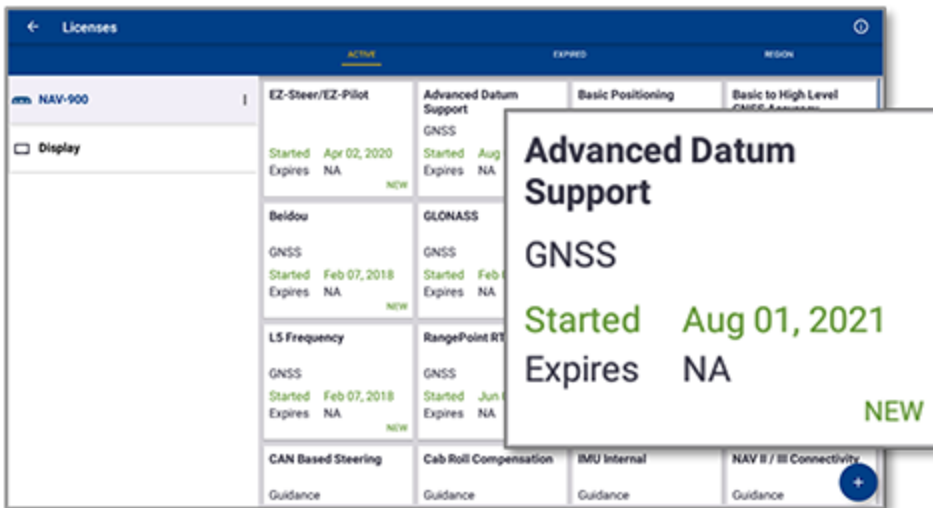

**NOTE** - Contact your authorized dealer for details about new features available for your display.



## Install a License from a USB Drive

1. On the App Central screen, tap the **Add** icon in the lower right corner:



2. Tap the **Install from USB** item:

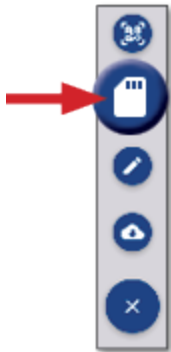

3. In the pop-up window for your USB drive, tap the license file you want to install. The license will be installed automatically.

**NOTE** - If the license does not install in App Central Licensing; verify the Serial Number of the display and the selected license file title to make sure that the proper **Serial\_Number.license** file was selected.

## Scan a QR Code to Install a License

Licenses can be installed via the scan of a QR code as an alternative to loading the file from a thumb drive for compatible displays.



1. On the App Central screen, tap the **Add** icon in the lower right corner:



2. Tap the **Scan QR Code** item and aim the display's camera at the QR code:



**NOTE** - The GFX-350/XCN-750 displays do not include a camera. Installing a license by scanning a QR code is not available with these displays.

- To scan more than one QR code, tap 
- When you are finished scanning, tap 

# Precision-IQ Overview

- ▶ Precision-IQ Home Screen and Run Screen Overview
- ▶ Common Icons in Precision-IQ
- ▶ Set Up and Select Precision-IQ Resources
- ▶ Operator Login and Permissions

The Trimble® Precision-IQ™ field application for supported displays is an easy-to-use advanced field management system. From the Launcher screen, tap the **Precision-IQ** widget to launch the application:





# Precision-IQ Home Screen and Run Screen Overview

Most of the field work is accomplished through the Precision-IQ Home screen and Run screen. This section provides a general tour of what you can expect to find on these screens.

**NOTE** – The Run screen will automatically update with the appropriate icons and features as you apply new licenses.

## Precision-IQ Home Screen Overview



Area	Description
1	<b>Activity</b> bar. Navigate to other activity functions. This bar is persistent for all screens in Precision-IQ.
2	<b>Status</b> bar. View an at-a-glance status of Precision-IQ features currently in use. You can also engage application coverage and auto steering.
3	<b>Resource</b> tiles. Tap these tiles to create and manage the resources used within Precision-IQ. Each tile shows the current resource selected or if a change is needed to accomplish a specific task. These tiles are only available when viewing the Home screen.
4	<b>Function</b> buttons: <ul style="list-style-type: none"> <li> Use the <b>Settings</b> button to customize the Precision-IQ environment.</li> <li> Use the <b>Data Transfer</b> button to transfer data to and from the display and to delete items from the display.</li> </ul>

## Precision-IQ Run Screen Overview

The Run screen shows the activity of the work being done in a field.

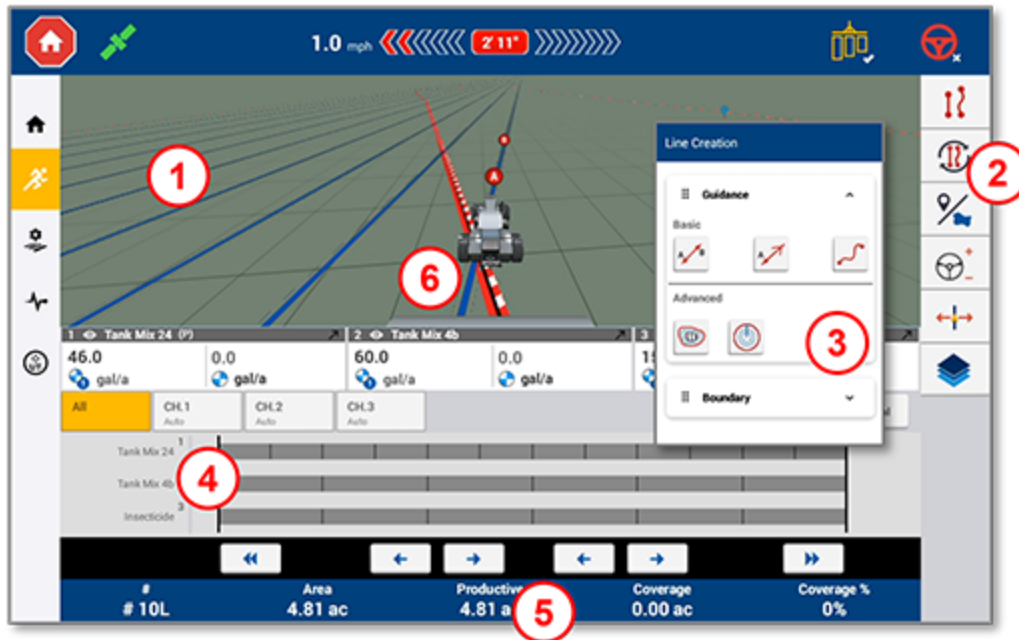

Area	Description
1	The <b>Virtual Map</b> shows the orientation and action of the vehicle. This map will automatically update to show guidance patterns, landmarks, etc.
2	The Run screen <b>Feature</b> buttons are available for you to update/configure a feature in real time. As you install licensed features, buttons for those features will automatically be added.
3	Tapping a Run screen feature button will open the <b>Feature Drawer</b> . For a selected feature, you can enable and configure it in real time. A variety of guidance, landmarks, patterns, recording, etc., buttons become available, as needed.
4	With an appropriate license installed, a wide variety of <b>Application Control</b> functions can be managed from the Run screen.
5	The <b>Information Bar</b> along the bottom shows the activity information. The details will be updated to show the work in progress. Swipe left/right to show additional details.
6	Touch and hold the <b>Vehicle</b> icon to change the view (following or over head), map orientation (north up or tractor nose up), and zoom back in after having been zoomed out.

### Run Screen Views

The Run screen is divided into virtual quadrants. You can choose how much or how little detail on which to focus, as in this example:

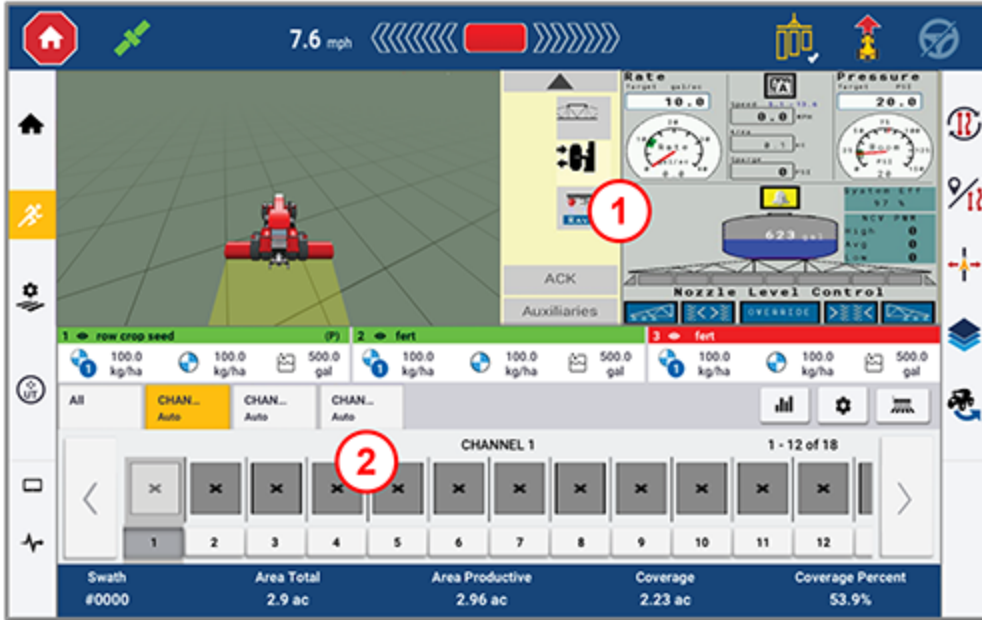

Area	Description
1	Universal Terminal
2	Application Control

**Collapse/Expand** icons will toggle the view to be full screen or basic size:



**Swap:** Some quadrants can display more than one view. If you see this icon in the upper-right corner of the quadrant, then long press it to switch between views:



**NOTE** - The presence of the Universal Terminal (UT) or Application Control quadrants appear based on the implement you have selected. When an implement is selected that is set up on the Home screen to perform Field-IQ or ISOBUS control, these quadrants will automatically appear.

### Customize Run Screen Functions

Tap a feature button to open a drawer where you can configure and modify on the fly, the settings for that function.

For example, tap the **Line Feature** button to open the Line Creation drawer. From here you can record a guidance line, pivot point, boundary, and more:

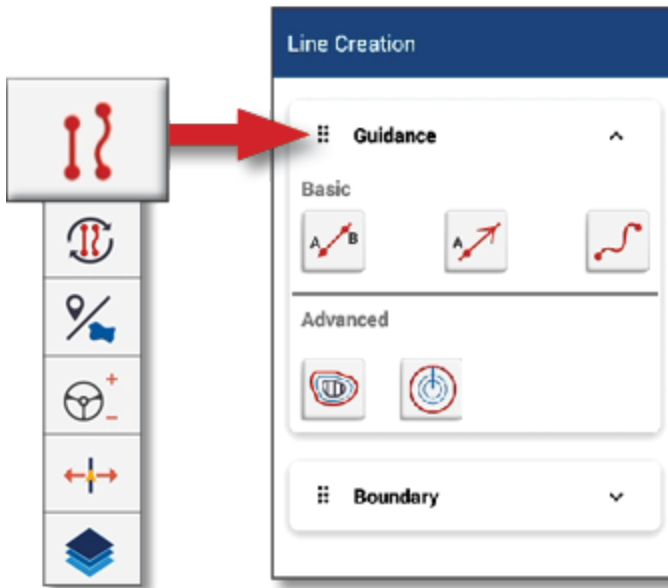







## Common Icons in Precision-IQ



The Precision-IQ user interface includes icons and buttons used to enable and configure a variety of functions and activities in the application. For details on how to configure and select Precision-IQ resources, contact your authorized Trimble Reseller.

### Precision-IQ Home Screen Icons

#### Activity Bar Icons







Icon	Description
	Return to the Precision-IQ <b>Home</b> screen.
	Return to the <b>Run</b> screen.
	Open the <b>Field Manager</b> . Customize and configure details about your field.
	Open the <b>Diagnostics</b> screen. Generate detailed reports on various Precision-IQ activities.
	Open the <b>Universal Terminal (UT)</b> . The UT is the interface for connected ISOBUS implements.
	Access an optional <b>External Camera</b> . If your system does not have an external camera, then this icon will not appear.

## Function Buttons

Button	Description
	Tap the <b>Settings</b> button to enable/disable, customize, and configure the features within the Precision-IQ environment. As feature and functionality licenses are applied, the list of settings will update to include the licensed feature.
	<p>Tap the <b>Data Transfer</b> button to transfer data to and from the display. Insert a USB drive into the USB port to transfer any data. See <a href="#">Data Transfer</a> for more details.</p> <p>Also, use the Data Transfer function to delete profiles for vehicles, implements, fields, tasks, materials, and users.</p> <p><b>NOTE</b> - Take care when deleting data. If your display is enabled for AutoSync, deleting data will erase it from your display and all connected AutoSync devices.</p>

## Status Bar Icons

The icons in the status bar will change to reflect the current activity being performed within Precision-IQ:







Icon	Description
	The <b>Run</b> button shows that work is ready to begin. Tap this button to enter the Run screen.
	The <b>Stop</b> button shows that work is being done in the Run screen. Tap this button to end a task and exit the Run screen.
	Check the <b>GNSS Status</b> with this icon. Tap this icon to show the number of satellites currently in use. Color coded to show at-a-glance GNSS and Correction status.
	When green, <b>Coverage Logging</b> is active. Color coded to show the different states.
	Enable <b>Autosteer</b> , when available. Color coded to show the different states: <ul style="list-style-type: none"> <li>• <b>Red</b> - not ready to engage</li> <li>• <b>Yellow</b> - ready to engage</li> <li>• <b>Green</b> - Engaged</li> </ul>
	<b>Vehicle Heading Swapper</b> . Changes the vehicle heading.



## Precision-IQ Run Screen Icons

**CAUTION** – Take care when setting up these details. The values you set in these steps are critical for in-field system performance and data integrity during run time operations.

### Run Screen Feature Buttons







Button	Description
	Tap the <b>Line Creation</b> button to open the Line Creation drawer to define the boundaries, pivots, and lines for your field.
	Cycle through the currently created guidance patterns for your field using the <b>Pattern Select</b> button.
	Tap the <b>Field Features</b> button to open the Field Features drawer for a variety of point, lines, and area landmarks to add to your field.
	Tap <b>Steering</b> to set the steering aggression.
	Tap <b>Nudge</b> to set the amount of Nudge previously configured in <i>Settings &gt; Steering and Guidance</i> . This button also takes you to <b>Remark</b> where you can <i>Remark to Here</i> or <i>Remark</i> by an amount.
	Tap <b>Layers</b> to see different aspects (layers) of coverage on the screen.

### Guidance Pattern Icons

On the Run screen, you can define boundaries, guidance patterns, and any number of landmarks.

Tap the **Line Creation** button to define the boundaries, pivots, and lines for your field:







Icon	Description
	Record a <b>Boundary</b> for your field. This setting defines the edges of your field.
	Create a <b>Headland</b> for your field. Use this pattern to complete the infield and give you room to turn.
	Record a <b>Pivot</b> for fields that are irrigated using a center pivot.
	Create a simple <b>AB Guidance Line</b> when you do not need a headland and you want to drive the field in parallel straight lines. AB lines are <i>always</i> parallel unless different AB line sets are made. Use <b>A+</b> to define a heading.
	Create an <b>A+ Directional Guidance Line</b> when you need guidance exactly parallel to the last AB line or on a desired heading.
	Record a <b>Curved Line</b> when you want to work the field with gentle curves.

## Landmarks Icons



On the Run screen, you can define a variety of point, lines and area landmarks.





Tap the **Field Features** button to define them for your field:



Icon	Description
	Create a <b>Landmark Point</b> for your field. A Landmark Point identifies singular elements of your field to be avoided, such as a well head, rock, gate location, etc.
	Create a <b>Landmark Line</b> for your field. Use this line to identify continuous elements of your field to be avoided, such as a fence, ditch, access road, etc.
	Create a <b>Productive Landmark Area</b> for your field, such as a crop zone.
	Create a <b>Nonproductive Landmark Area</b> for your field, such as a pond, marsh, or area that does not need to be worked again.

## Recording Buttons

Button	Description
	<b>Record</b> a guidance pattern.
	When recording a guidance line, tap to <b>Set A</b> .
	When recording a guidance line, tap to <b>Set B</b> .







Button	Description
	Once you are satisfied with the guidance pattern recording, tap <b>Complete</b> .
	<b>Pause</b> the recording of a guidance pattern.
	<b>Cancel</b> the recording of a guidance pattern.
	<b>Vehicle Heading</b> changes the vehicle heading.

## Set Up and Select Precision-IQ Resources

The Precision-IQ Home screen contains the resources you will use when performing work in a field. Tap a resource tile to set up and select a profile for the task you want to complete.

**CAUTION** – Take care when setting up these details. The values you set in these steps are critical for in-field system performance and data integrity during run time operations.

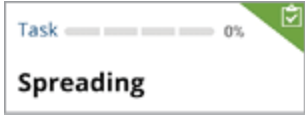



### Resource Tile Overview

Tile	Description								
 <p>GNSS <b>RangePoint RTX</b></p>	The <b>GNSS</b> resource tile shows the selected method of GNSS correction. Tap this tile to select and configure the GNSS settings.								
 <p>Vehicle Profile <b>Case IH Profile A</b></p>	The <b>Vehicle Profile</b> resource tile shows the selected vehicle profile. Tap this tile to create and manage the configurations for a variety of vehicles. With an installed autoguidance license, the settings for this supported feature become available.								
 <p>Implement <b>3 Point Spreader</b></p>	The <b>Implement</b> resource tile shows the selected implement profile. Tap this tile to create and manage the configurations for a variety of implements. With an installed application control license, the settings for this supported feature become available.								
 <p>Material <b>Lime</b></p>	The <b>Material</b> resource tile shows the selected material profile for a particular task. Tap this tile to create and manage the profiles for a variety of materials to be used with application control.								
 <p>Field Field North Corner</p>	The <b>Field</b> resource tile shows the selected field of a farm. A farm may have more than one field, and a client may have more than one farm. Tap this tile to create, manage, and select a field. A field <b>must</b> be selected before any work can be performed.								
 <p>Task 0% <b>Spreading</b></p>	The <b>Task</b> resource tile will update to work with the selected implement and material resources. Tap this tile to create or select a task.								
 <p>System PRECISION IQ</p> <table border="1"> <thead> <tr> <th>DEVICE</th> <th>STATUS</th> </tr> </thead> <tbody> <tr> <td>GFX-1060</td> <td>✓</td> </tr> <tr> <td>NAV-900</td> <td>✓</td> </tr> <tr> <td>Internet</td> <td>✓</td> </tr> </tbody> </table>	DEVICE	STATUS	GFX-1060	✓	NAV-900	✓	Internet	✓	The <b>System</b> resource tile shows the status of all hardware devices in the Precision-IQ environment, including internet connectivity. Tap this tile for additional information on the devices. This information can be useful when troubleshooting a connectivity issue.
DEVICE	STATUS								
GFX-1060	✓								
NAV-900	✓								
Internet	✓								

**NOTE** – For configuration details of specific Precision-IQ resources, contact your authorized Trimble Reseller.

## Resource Tile Color Codes

Each resource tile is color coded to show you at-a-glance status of each resource:

Tile Color	Color Definition
 <p>Resource Selection</p>	<p><b>Green</b> indicates the resource has been properly selected and configured for entering the Run screen.</p>
 <p>Resource Selection Tap to select</p>	<p><b>Red</b> indicates the resource has not been selected, that the selected resource contains a configuration error or that a peripheral device, or resource required by the resource is not connected or has a conflict. You cannot enter the Run screen.</p>
 <p>Resource Selection Tap to select</p>	<p><b>Yellow</b> indicates that the selection of a resource is required but has not yet been made or that the selected resource requires the selection of another resource.</p>
 <p>Resource Selection</p>	<p><b>Gray</b> is reserved for the Vehicle tile and shows that the vehicle is ready for use.</p>

## Create a Resource Profile

Precision-IQ provides a variety of resources you must select for the task you need to complete. For example, tap the **Vehicle** tile to display the currently selected vehicle profile:

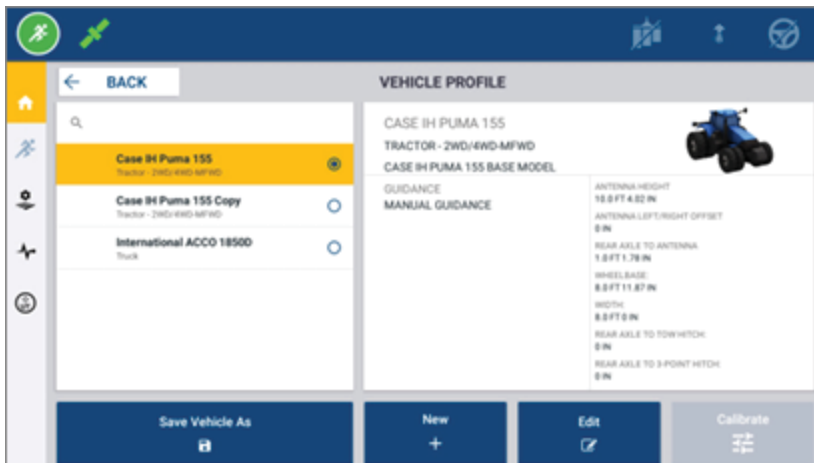

The profile screen shows the available profiles that you can select. Tap a profile to update the screen with a detailed summary of the profile.

To create a new profile, tap the **New** button at the bottom of the screen.

Depending on the resource profile you want to create, Precision-IQ will launch a profile wizard to collect the necessary details for the resource. Some resources - such as the vehicle and implement profiles - require a set of precise measurements. You can always update a profile by tapping the **Edit** button.

Precision-IQ resources can be created in backend office software, such as Trimble Ag Software. See [Data Transfer Overview](#) for information on transferring resources to your display.

**NOTE** - While certain guidance types may be available for your selected machine, only guidance types with the corresponding guidance license installed on your steering controller will appear.

## Select a Resource Profile

Once created, a resource must be *selected* before you can perform any work. In this example, tap the **Implement** tile, then:

1. Select a new profile.
2. Tap the **Select Implement Profile** button.

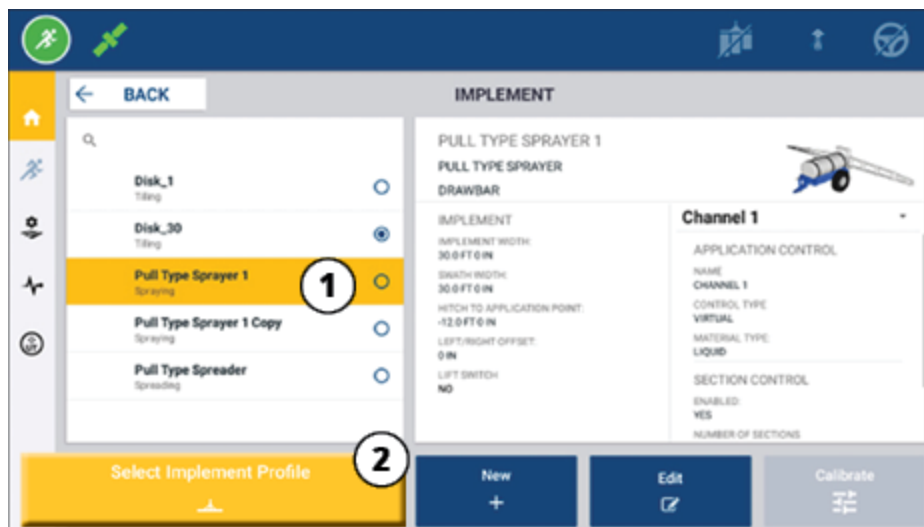

## Copy an Existing Resource Profile

Precision-IQ can manage as many resource profiles as you need. Because many resources can have the same information, you can save time by copying the resource profile. With a duplicate profile, you can then edit the resource details to suit the task you expect to work.

In this example, tap the **Implement** tile, then on the Implement Profile screen:

1. Tap a profile from the list of available implement profiles that you want to copy.
2. Tap the **Save Implement As** button:

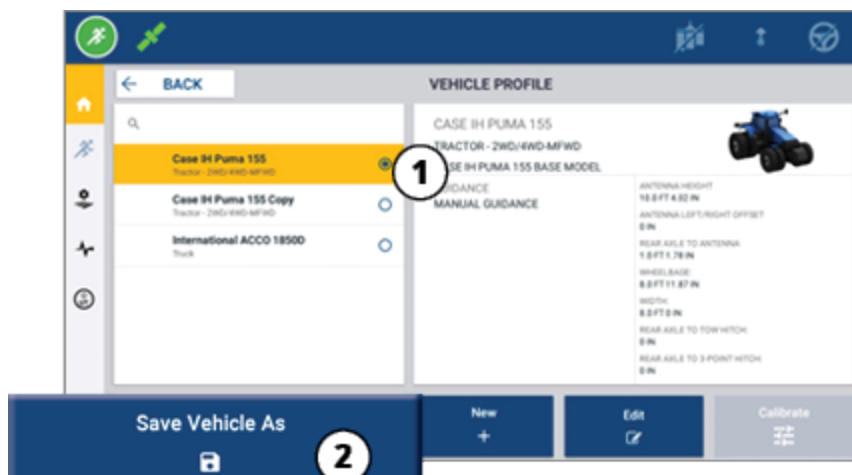



## Licensed Features

A license that you add for Precision-IQ will be integrated into the resource profile. As you create/modify a resource profile, a licensed feature will be added as a new step for configuration. For example, NextSwath™ is a licensed feature you can include for supported implements. Once applied, the option to enable this feature is now part of the profile configuration:

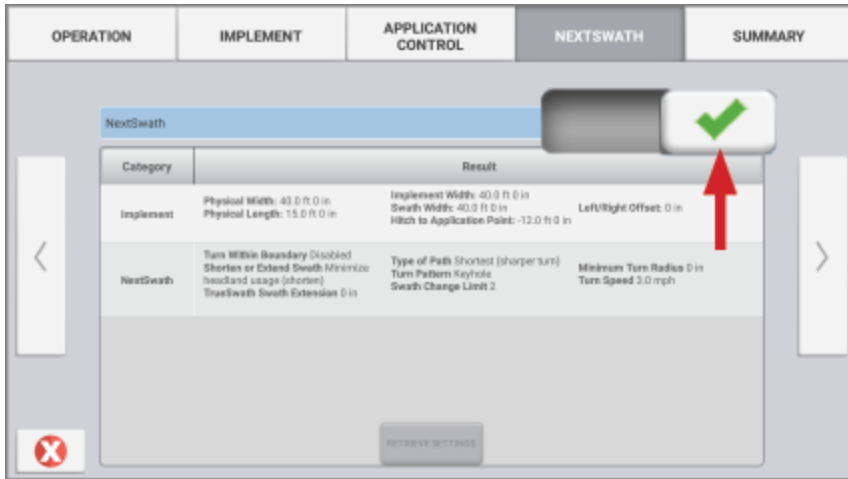

**NOTE** – Contact your authorized dealer for details on installing and configuring licensed features.

## Operator Login and Permissions

With AutoSync enabled, organization administrators can use Trimble Ag Software (online or the mobile app) to manage operators and access permissions for Precision-IQ displays. Permission settings can restrict operators from creating and editing a variety of Precision-IQ resources and Run screen functions.

Administrators have a choice on how an operator can access the Precision-IQ display or application:

- **Cloud-based Operator Permissions.** Operator logins and permissions are set by Trimble Ag Software (online or the mobile app) for accessing the Precision-IQ display. These operators will have permissions granted for full or limited access to Precision-IQ functionality. *Full-access* users can do anything in the display while *select-only* users can only select what is already on the display. With AutoSync enabled in Trimble Ag Software (online or the mobile app), this method is recommended when there are several potential operators or complex farms.

OR

- **Display-based Operator Login.** Only operator accounts can be created and edited within the Precision-IQ application itself (no permissions can be set). This functionality has not been changed from previous versions of Precision-IQ. This method is recommended if you need to control the display login - but not have an active Trimble Ag Software account.

To set operator permissions as described in this section, you must:

- Update Precision-IQ to the latest firmware (6.20 or later).
- Update the Trimble Ag Software mobile app to the latest firmware (3.3 or later).
- An active organization must exist in Trimble Ag Software.
- AutoSync must be enabled.

## Trimble Ag Software: Operator Permissions Setup

**NOTE** - These instructions assume that AutoSync is enabled and that Operators sync is set to **On**.

1. Turn On Operator Display Sign-in (*global setting*). By default, the Operator display sign-in option is set to **OFF** for all operators.

**NOTE** - The Operator Display Sign-in setting allows equipment operators who have Precision-IQ access to be shared across all connected devices.

To update the setting:

- a. On the Trimble Ag Software home screen, click the **Contacts** tile.
- b. On the list of contacts, locate the **Operator display sign-in** setting in the upper-left portion of the

screen.

- c. Click **Change**, then select **On** from the pop-up window. Click **Save**.

**NOTE** – When AutoSync is turned on, operator logins cannot be edited from the Precision-IQ display.

2. Set Operator Precision-IQ Access Permissions for an organization contact. To change this setting:
  - a. Edit an existing operator contact.

**NOTE** – You can also add a new contact. A new contact will need to enable the Equipment Operator option.

- b. On the Contact Properties screen, click the **Equipment Operator** tab.
- c. Click the **Trimble Display Permission** box and set the following options:
  - **Sign-in ID:** This value is auto-generated based on the contact’s first and last name, which must be unique to the organization.
  - **4 Digit PIN:** Enter a four-digit operator PIN to be used to access the Precision-IQ display.
  - **Operator display sign-in:** This should be set to **ON**. This setting is global for the organization and applies to all operators.
  - **Precision-IQ Access:** Click the drop-down menu to change the access settings from **Full Access** to **Select Only**. By default, a new operator profile has the Precision-IQ Access option set to **Full Access**.

Operator Permission	Description
<b>Full Access</b>	An operator, upon logging in to a Trimble display, may use all licensed features and functionality of Precision-IQ. This level of permissions is the default setting.
<b>Select Only</b>	An operator, upon logging in to a Trimble display, can only select existing equipment, boundaries, landmarks, or guidance lines but cannot edit or create them in Precision-IQ. (“Guest” is a select only user)

3. Once you have completed the operator profile, click **Save**. The list of contacts will update to show the Precision-IQ Access level (**Full Access** or **Select Only**).

# Trimble Ag Software Mobile App: Operator Permissions Setup

Follow the steps below to set up operator permissions using the Trimble Ag Software mobile app on your smartphone or tablet:

## NOTE –

- Only organization administrators can modify equipment operator permissions.
- The Trimble Ag Software mobile app can activate Trimble display permissions and set Precision-IQ access for a contact.
- In the mobile app, you can create/edit contact details in order to:
  - Assign them as equipment operators.
  - Give them Trimble display login permissions.
  - Set a Precision-IQ access level.

1. Select a contact you wish to give Trimble display login and access. With a contact selected, tap the **Edit** icon (the pencil on the top-right of the screen).
2. Verify the Equipment Operator option is selected. If it is not selected, then tap the box to enable.

**NOTE –** You can also update other options such as Applicator Licenses, Unit Cost per hour, etc.

3. Enable Trimble Display Permissions. Tap the box to enable Trimble Display Permissions:

**NOTE –** Operator display sign-in on/off is a global setting set within Trimble Ag Software.

4. Assign a four-digit PIN. Tap the **4 digit PIN** option and assign a code for the operator in the pop-up window. Tap **Close**.

**NOTE –** The **Sign in ID** is automatically created by the software when the contact is created. The format is the **first name** and **last name**.

5. Assign Precision-IQ access:
  - a. Tap the **Precision-IQ Access** option.
  - b. In the Precision-IQ Access pop-up window, select **Full Access** (default) or **Select Only**, then tap **Close**.

Operator Permission	Description
<b>Full Access</b>	An operator, upon logging in to a Trimble display, may use all licensed features and functionality of Precision-IQ. This level of permissions is the default setting.
<b>Select Only</b>	An operator, upon logging in to a Trimble display, can only select existing equipment, boundaries, landmarks, or guidance lines but cannot edit or create them in Precision-IQ. ("Guest" is a select only user)

6. Save. After you have updated the contact details, tap the **Save** icon on the top-right of the screen.
7. Return to the Home screen and tap the **manual sync** icon .

**NOTE** - You must sync manually for all changes to be updated across the organization.

## Login to a Precision-IQ Display

After the Operator display sign-in option has been set (using Trimble Ag Software), the login interface to the display is updated:

1. On the login screen, tap the > icon:

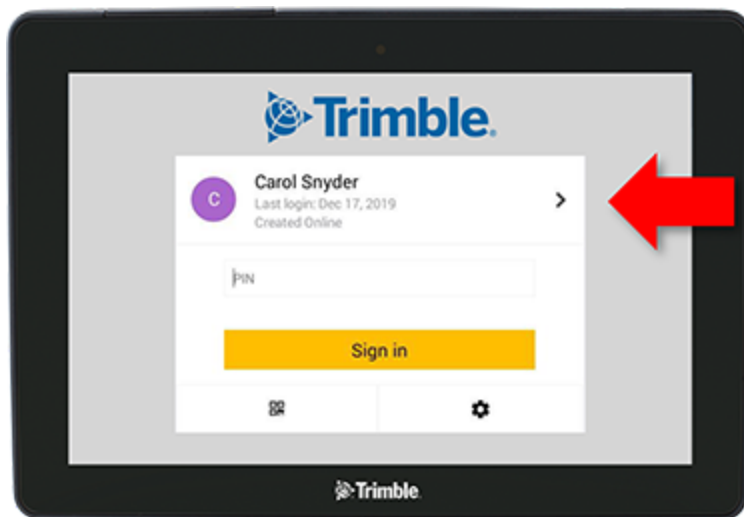

2. Select the operator from the list.

**NOTE** - This operator list only includes operators that have the **Trimble Display Permissions** option enabled within Trimble Ag Software or Trimble Ag Mobile.

3. Enter the operator PIN and tap **Sign in**.

# System Settings

- ▶ [Android Settings](#)
- ▶ [Precision-IQ Settings](#)

A variety of settings are available for Precision-IQ to be customized for your own unique environment. Precision-IQ also accommodates the Android settings you select.

## For Precision-IQ Settings

Tap the **Settings** button on the Precision-IQ Home screen:



## For Android Settings

Tap the **Settings** icon on the Launcher screen:



# Android Settings

Android settings affect a variety of features and functions for all applications on the display. On the Launcher screen, tap the **Settings** icon:



On the Android Settings screen, Precision-IQ references the settings for wi-fi, display, language, etc.:

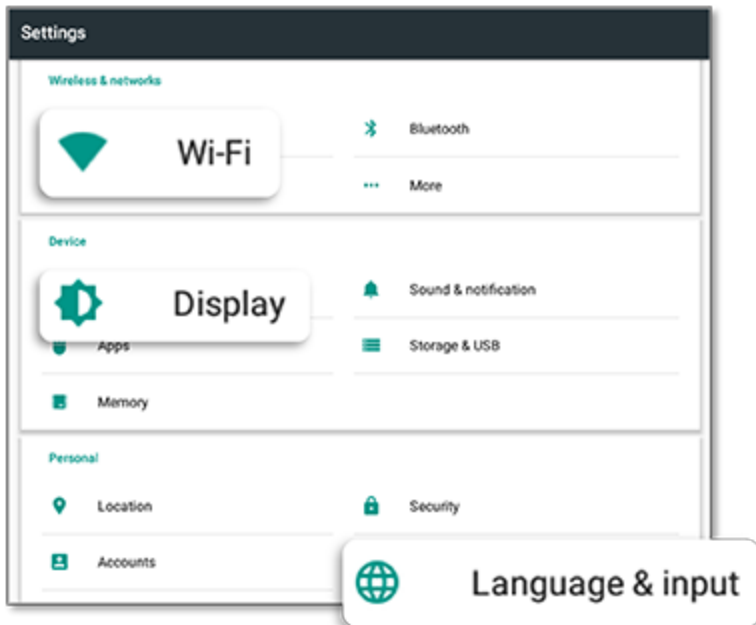

Tap a setting for options to enable, disable, and choose a setting option:

**Wi-Fi:** Tap the slider to enable and select from available wi-fi networks:



**Language:** Tap to select a language. Precision-IQ supports most languages:

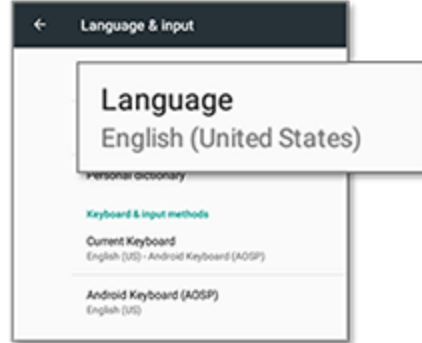

**Display:** Tap to adjust the brightness level and to enable adaptive brightness:



**Date/Time:** Tap to select your time zone and to display the time as 12-hour or 24-hour:





## Precision-IQ Settings

Many of the features and functions of Precision-IQ have default settings that you can change, as needed. On the Home screen, tap the **Settings** button at the bottom of the screen:



On the Settings screen, tap the setting you want to update. The screen will refresh to display the available setting options. Tap each option to update, as needed. When you are satisfied with your selection, tap **Back** to save the settings and to return to the Precision-IQ Home screen.

## Precision-IQ Setting Examples

The following settings show examples of the type of options you can change:

### Display Setup:

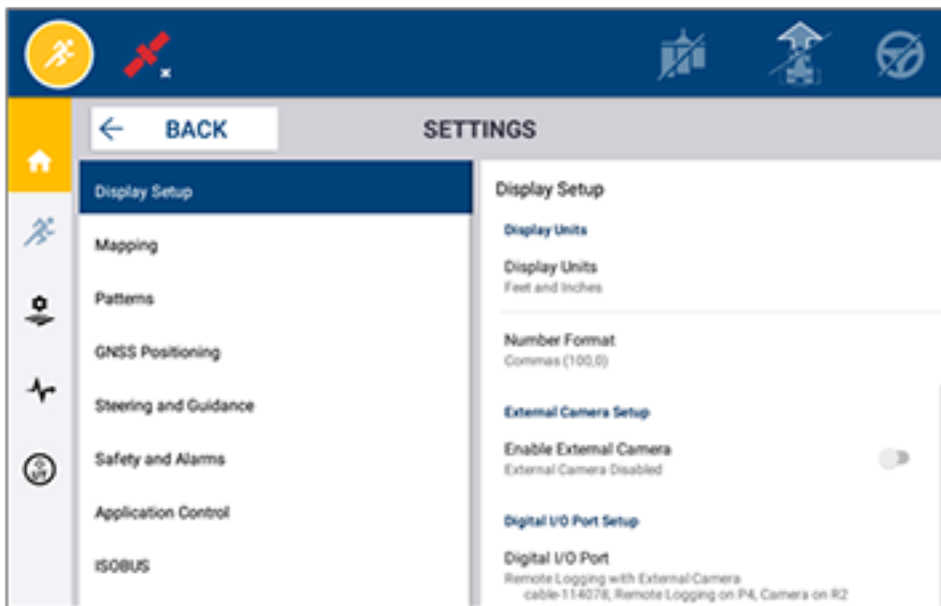

Steering and Guidance:

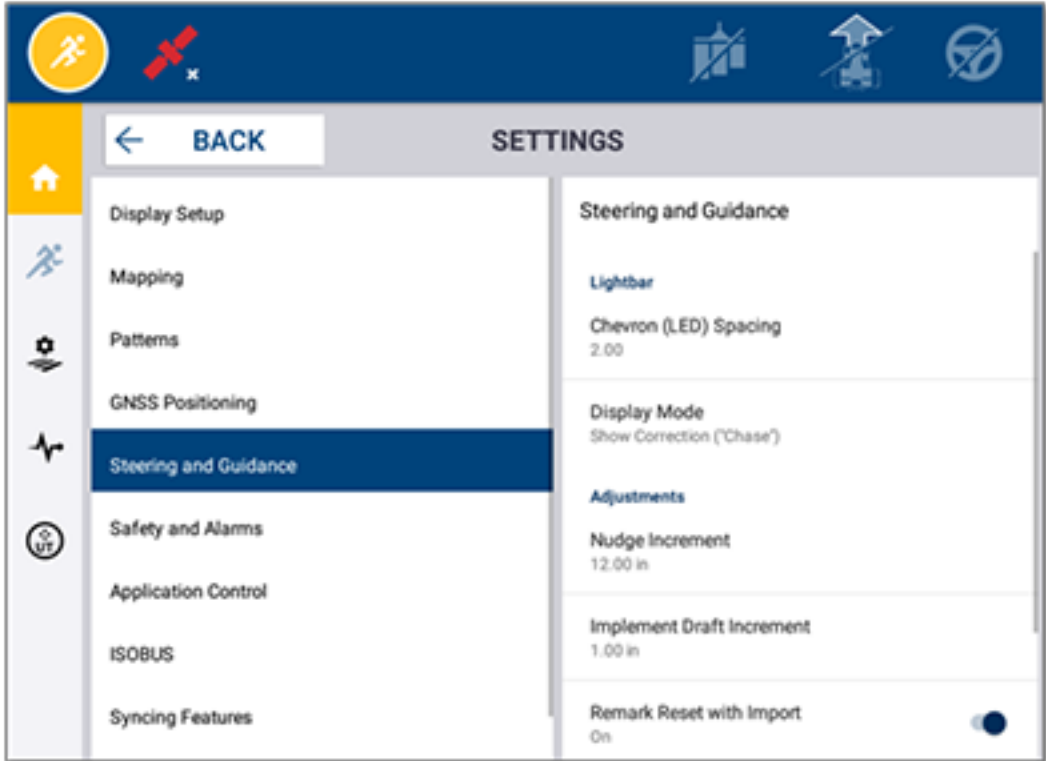

Application Control:

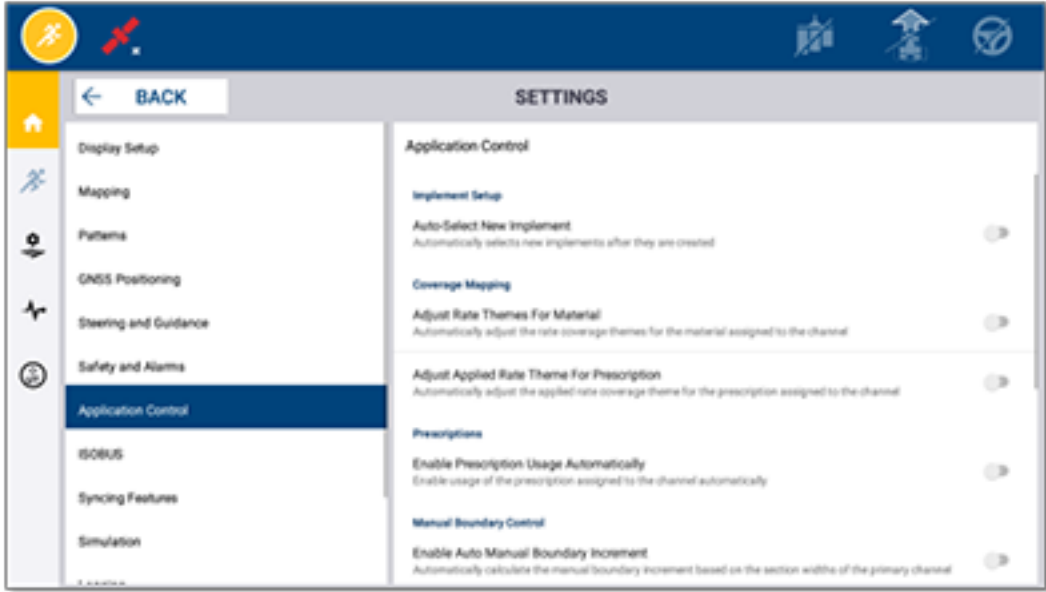

Some Precision-IQ features can be simulated for demonstration, testing, or training. Tap the appropriate slider to enable and disable a simulation feature:

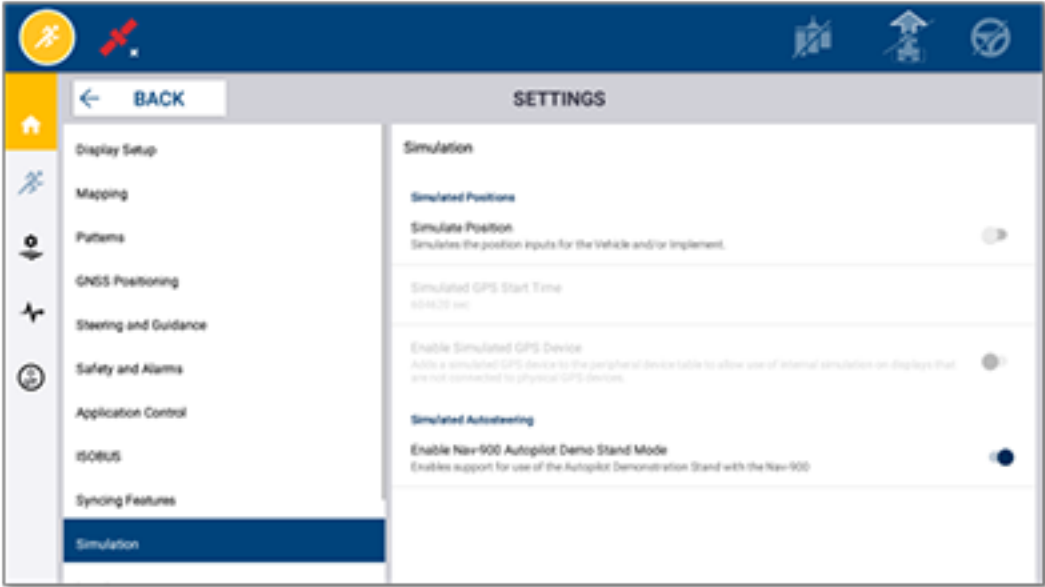

# Data Transfer

- ▶ [Data Transfer Overview](#)
- ▶ [AutoSync Overview](#)
- ▶ [Setup and Configuration for Wireless Data Transfer](#)
- ▶ [Using Data Transfer Wirelessly](#)
- ▶ [Using Data Transfer Manually](#)
- ▶ [Delete a Precision-IQ Resource](#)

Precision-IQ provides support for the transfer of data between a display in the field and the Trimble Ag Software you use in your back office or you can manually transfer data using a thumb drive. From the Precision-IQ Home screen, tap the **Data Transfer** button to begin:



## Data Transfer Overview

Precision-IQ provides support for the transfer of data between a display in the field and the Trimble Ag Software you use in your back office. The collected data from your display can be transferred:

- **Wirelessly** using the AutoSync™ feature through a cellular or Wi-Fi network.

It is recommended to use the wireless option because data transfers can be configured to be done automatically and seamlessly.

### NOTE -

- The GFX/XCN displays include Wi-Fi functionality built-in.
- To connect a TMX-2050™ or XCN-2050™ display to a Wi-Fi network, see the [TMX-2050 Display: Supported Wi-Fi and Mobile Tethering Devices](#) support bulletin.
- For other connection options, see the *AutoSync: Connectivity Guide* section of the [AutoSync User Guide](#).

When a wireless communication is established, all jobs that are completed in the field (using required hardware) are sent to the web server for Trimble Ag Software. In addition, the display looks for updated information to download from your Trimble Ag Software storage area. If you lose communication with the web server, then your completed jobs are sent once communication is reestablished.

- **Manually** using a USB device. All GFX/XCN displays include at least one USB port for manual data transfer.

Use the manual option when no network connectivity is available or connection is poor.

## AutoSync Overview

**NOTE -** AutoSync is wireless data transfer for displays with Precision-IQ firmware version 6.xx and higher.

AutoSync automatically syncs farm data across Trimble displays utilizing Precision-IQ software, eliminating the need to manually share data via USB. AutoSync significantly reduces duplication, data re-entry, and human error because field, resource, and operator information — whether online, via the Trimble Ag mobile app, or on the display — is automatically synced by the minute across the entire farm operation.

The AutoSync feature is included with Farmer Core and Farmer Pro software subscriptions. Display Connections licenses are required for each connected Trimble display.

AutoSync exchanges guidance lines, field boundaries, client/farm/field names, landmarks, vehicles, materials, implements and operators. When the task is completed, task data will transfer from the displays to the online platform. Customers with appropriate permissions can create, edit, and delete from any of the connected devices, automatically updating the other devices within a few minutes:

Data Type	Create	Edit	Delete
<b>Guidance Lines</b>	✓	✓	✓
<b>Client/Farm/Field Names</b>	✓	✓	✓
<b>Landmarks and Boundaries</b>	✓	✓	✓
<b>Operators</b>	✓	✓	✓
<b>Vehicles</b>	✓	✓	✓
<b>Materials</b>	✓	✓	✓
<b>Implements</b>	✓	✓	✓

Using the wireless capabilities of AutoSync, you can:

- **Save Time** — Share farm data across all supported devices used in the operation, eliminating dual entry of data.
- **Improve Efficiency** — Ensure definition and use of guidance lines is consistent for all operators through automatic syncing.
- **Reduce Human Error** — Improve integrity of records by eliminating errors caused by multiple entry of guidance lines, field names, field boundaries, resources, and landmarks.
- **Leverage Two-Way Data Transfer** — Powered by AutoSync, Trimble Ag Software solutions enable automatic two-way data transfer with supported displays.
- **Satisfy Regulatory and Contractual Obligations** — AutoSync enables easy creation of application coverage maps (proof of placement reports).

For details about the prerequisites and configuration for AutoSync, refer to the [AutoSync User Guide](#) and the [AutoSync Support Workflow](#).

# Setup and Configuration for Wireless Data Transfer

To establish an effective wireless data transfer, Precision-IQ must be properly set up and configured to collect the appropriate data to be transferred. This section describes how to set up and configure your display for wireless data transfer.

FarmStream ties into the vehicle CAN and enables productivity data to be transferred, such as when a machine is running or stopped, to Trimble Ag Software and includes real-time vehicle location and status information.

For more information on FarmStream and how it compares to Trimble Ag's traditional telematics solution visit:

<https://agriculture.trimble.com/software/farmstream-faq/>

Likewise, Trimble Ag software should be configured to receive a data transfer from Precision-IQ. Refer to the websites below for information about Trimble Ag software:

- General information on how to set up and configure Trimble Ag software:

<https://agriculture.trimble.com/software/support/how-to-central/>

- New vehicle setup instructions:

<https://agriculture.trimble.com/software/support/fleet-help/#CreatingANewVehicle>

- Vehicle connection license assignment instructions:

<https://agriculture.trimble.com/software/support/fleet-help/#AssigningVehicleLicense>

Follow the steps below to set up and configure Precision-IQ for wireless data transfer using FarmStream:

## Configuring FarmStream Settings

**NOTE** – The Productivity tab is only visible if the **Enable Operators** feature is turned on. This feature is accessed by tapping **Settings** on the Home screen and selecting **Operators and Passwords**.

To use the Utilization app and FarmStream Fleet reporting on the display with Precision-IQ field application, you must first set up the thresholds in the Precision-IQ application.

### *Setting Vehicle and Implement Thresholds for FarmStream Reporting*

After opening Precision-IQ, you can set up the Implement and Vehicle settings for the Utilization app, so the utilization data shows up as you want it to in FarmStream Fleet.

1. On the Precision-IQ Home screen, tap the **Vehicle** tile to set the vehicle settings. Then tap the **Productivity** tab.

In the Productivity tab, set a threshold for the vehicle maximum moving speed for the Utilization app. Any time that the vehicle travels over this maximum moving speed, it is reported as speeding. If you turn the Maximum Moving Speed off this means that the “speeding” state will not be used for the vehicle in FarmStream Fleet.

- To set the maximum moving speed option, tap **Maximum Moving Speed**. Choose a maximum moving speed for the vehicle and then tap the green check button. There is also an option to display the speed in US or Metric units. The range of the allowed moving speed that can be selected is noted in the dialog:

- Tap the **Summary** tab and save your changes.
- Return to the Precision-IQ Home screen and tap the **Implement** tile to set the Implement thresholds for the Utilization application. Then tap the **Productivity** tab.

If an operator exceeds the functional speed for an implement, possible damage can occur to the implement, the vehicle, the crop or the field. The display can send information about the implement status to FarmStream Fleet in the Trimble Ag Software solution.

**NOTE** – The Productivity tab is only visible if the Enable Operators feature is turned on. This feature is accessed by tapping Settings on the Home screen and selecting Operators and Passwords.

These settings determine what information is sent about the implement from the Utilization application to FarmStream Fleet.

- To set the Maximum Transport speed, tap **Maximum Transport Speed** and enter a value in the range indicated. Select the Units, if required. Tap the green check to save.



### Maximum Transport Speed

---

Enter a value between 0.00 and 90.00 mph  
mph

12.54

Units





6. Tap **Maximum Operating Speed** and **Stopped To Delayed Timeout** to set the values and/or select units for these two parameters. Tap the green check to save.
7. Tap the **Summary** tab and save your changes.

The table below describes the different settings options:

Setting	Description
<b>Maximum Transport Speed</b>	<p>The functional speed limit for transporting the implement. The options are <b>On</b> or <b>Off</b> and a numerical value for the speed.</p> <p><i>Maximum Transport Speed</i> is used to determine when a vehicle enters the “speeding” state. The minimum of Maximum Transport and Maximum Moving speed will be used in this determination; Maximum moving speed is configured under the vehicle setup (Productivity tab).</p> <p>If Maximum Transport Speed is turned off, then the Maximum Moving Speed for the vehicle is used to determine the “speeding” threshold (if Maximum Moving Speed is turned on).</p>
<b>Maximum Operating Speed</b>	<p>The functional speed limit for the implement when coverage logging is on. The options are <b>On</b> or <b>Off</b> and a numerical value for the speed.</p> <p><i>Maximum Operating Speed</i> is used to determine when the vehicle enters a “rushing” state.</p>
<b>Stopped to Delayed Timeout</b>	<p>The length of time the vehicle can be paused before the vehicle is considered delayed. The options are <b>On</b> or <b>Off</b>.</p> <p><i>Stopped To Delayed Timeout</i> is the amount of time that will pass after the vehicle has entered a “stopped” state before it’s considered to be in a “delayed” state (and the operator may be prompted to select a reason for the delay).</p>

## Setting up an Operator for FarmStream Reporting

**NOTE** – The **Enable Operators** feature must be enabled in order for FarmStream to run. This feature is accessed by tapping **Settings** on the Home screen and selecting **Operators and Passwords** or by enabling operators from the Trimble Ag Software using the enable option at **People ⇒ Contacts ⇒ Manage ⇒ Operator Display Sign In**.

Signing in as an operator is not required for Utilization or FarmStream to run, but if you want to see operator information in the application, you must sign in.

To set up operator information, turn on your display. You should see the Operator app. Tap the **Operator** app icon to launch it.

Operators can be created in the **Fleet** or **Farm ⇒ Contacts** page of the Trimble Ag Software. All operators in the display's organization are automatically sent to the display when it has connectivity. If operators in the Fleet page are changed, any changes will be visible in the Operator app after the app has been killed and restarted, or when the display has rebooted.

Operators can also be created locally on the display, but they will not be sent to the Trimble Ag Software to be seen on the Fleet page unless AutoSync is turned on. These local operators will not show in the menu in the Operator app.

1. Login to the Operator app in order to track who is using the vehicle, for reporting in the Utilization app and FarmStream.
2. Enter or scan your operator PIN to login.

Once logged in, the operator information will be recorded along with any utilization data.

## Enabling an Operator for FarmStream Reporting

**NOTE** – Enabling operators is required for FarmStream operation. For more details on how to set up the software and display for FarmStream, refer to the FarmStream guide here:

<http://agriculture.trimble.com/software/farmstream-setup/>

If you want to see operator information in your Trimble Ag software application as part of a data transfer, then there must be an operator enabled to use Precision-IQ, with the Enable Operators setting active.

For details on how to manage operators using Trimble Ag software, visit:

<https://agriculture.trimble.com/software/support/fleet-help/#OperatorsScreen>

Once logged in, the operator information will be recorded along with any utilization data.

## Using Data Transfer Wirelessly

Once Precision-IQ is configured, the FarmStream utilization data collected is sent to Trimble Ag software as often as every few seconds. When you enter the Run screen to perform a task, Precision-IQ begins to record the utilization data and it can be sent.

For details on what to do with the utilization data sent to Trimble Ag software, visit:

<https://agriculture.trimble.com/software/support/fleet-help/#Utilization>

## Transferring Data Wirelessly to the Display Using Trimble Ag Desktop Software

**NOTE** – For displays using Precision-IQ firmware version below 6.xx.

For details on how to access transferred files in the Trimble Ag Software visit:

<https://agriculture.trimble.com/software/support/fleet-help/#DownloadingandUploadingFiles>

Follow the steps below to upload data to the display using desktop software:

1. Go to the **Online** tab in the desktop software and log on with your Trimble Ag Software username and password. If applicable, select the organization you are working with.
2. Click **Send Resources**.  
Use the Send Resources button to specify data you want uploaded to Trimble Ag Software server so it can be downloaded to your display.
3. In the **Farms/Fields** tab, select the **Clients/Farms/Fields** to upload.
4. In the **Inputs** tab, select the **Machines/People/Supplies** to upload.
5. Select **Job Types** to be sent.
6. Select the **Options** tab to send field boundaries and/or guidance lines.
7. Click **OK**.
8. Select **Trimble Display(s)** to upload resources to and click **OK**.
9. Selected resources are added to Outbox for mobile devices that you chose.

As soon as software communicates with Trimble Ag Software server, data is uploaded and moved to the device Inbox where it stays until the display downloads the resources.

# Using Data Transfer Manually

Precision-IQ supports data transfer using a USB drive (also known as a *thumb drive* or *flash drive*). To manually transfer data, you must insert a USB drive into one of the USB ports on the display, and then select the files you want to transfer.

Follow the steps below to transfer data manually:

1. Insert a USB drive into one of the USB ports on the display.
2. From the Precision-IQ Home screen, tap the **Data Transfer** button to display the Data Transfer screen.
3. Select a data transfer action:
  - [USB VDB Transfer](#)
  - [Data Transfer Between Precision-IQ Displays](#)
  - [Export Precision-IQ Resources to a USB Drive](#)
  - [Import Resources to a Precision-IQ Display](#)
4. Once the data transfer is complete, you can remove the USB drive from the display.

## **See also:**

[Supported Data Transfer Functions](#)

[Delete a Precision-IQ Resource](#)

## USB VDB Transfer

When you transfer data, saved vehicles do not include the vehicle configuration file (.vdb) for Autopilot™. To transfer this configuration data:

1. Connect a laptop that has the Autopilot Toolbox software to the serial port of the NavController that contains the vehicle config file you want.
2. Using Autopilot Toolbox, save the config (.cfg) file to the laptop.
3. Transfer the saved config file from the laptop to a USB drive in the folder **AgData/Profiles**.
4. Make sure you have the Precision-IQ application open.
5. Insert the USB drive containing the config file in the USB socket of the display.
6. Insert the USB drive containing the config file in the micro USB adapter cable.

## Data Transfer Between Precision-IQ Displays

To copy resources from your Precision-IQ display to a USB drive for use in another Precision-IQ display:

1. Insert a USB drive into the display.
2. On the Home screen, tap **Data Transfer** to open the Data Transfer screen.

On the Data Transfer screen, make sure that the **Show All USB Files** option is **deselected**:

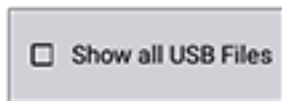

3. Select the folders or resources you want to copy and tap the **Copy** button.

**NOTE** – Some AgGPS resources can be read by AgData. If you have an AgGPS file with recognizable resources (such as a *Field*) on the root level of your USB drive, then it will appear along with the AgData resource and can be copied directly to the display.

## Export Precision-IQ Resources to a USB Drive

To convert and copy resources from your Precision-IQ display to a USB drive for use in another display or to Trimble Ag Software:

1. On the Data Transfer screen, make sure that the **Show All USB Files** option is **selected**.
2. On your USB drive pane, navigate to the location where you want to copy the converted files to.

**NOTE** – Use caution for selecting a location. Some USB drives can contain multiple of files and folders. Be sure you know where you want the converted Precision-IQ to be located.

3. On the Internal (display) pane, navigate to the folders and resources you want to convert and select them. Tap the **Copy** button. In the Copy As pop-up window, select a data type (AgData, AgGPS, ISOXML):

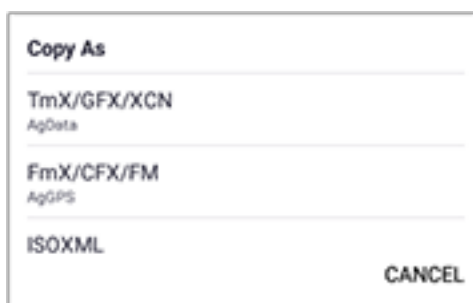

**NOTE** – Not all Precision-IQ resources can be converted. A warning message will display for those resources that cannot be converted.

- The resource will be converted to the appropriate format and copied to the USB drive. If you are transferring resources **from** Precision-IQ **to** a USB drive, then the converted resources will appear in an **Output\_AgGPS**, **Output\_AgData**, or **Output\_ISOXML** folder, depending on the file type you want transferred. You should be able to import these resources into your FmX+ or Trimble Ag Software applications.

**CAUTION** – If you are exporting data for use in an AgGPS-supported display, you **must** first move the converted AgGPS folder out of the Output\_AgGPS folder to the root level of the USB drive, so that it can be recognized by the display.

## Import Resources to a Precision-IQ Display

Precision-IQ can recognize both AgData and AgGPS data types on a USB drive. To import these resources from a USB drive to your Precision-IQ display:

- On the Data Transfer screen, select the folders or resources you want to copy.

**NOTE** – The "Show All Files" option does not need to be selected to import AgGPS data. This data appears under the profile selection.

- Tap **Copy**.
- Tap **OK** on the confirmation pop-up window.

## Supported Data Transfer Functions

Not all resource types can be manually transferred to/from Precision-IQ into other formats (AgGPS, ISOXML). The following table shows the functions and formats supported by the Precision-IQ's data transfer service.

Profile	From Precision-IQ to:		
	USB (AgData)	USB (AgGPS)	ISOXML
<b>Vehicles</b>	✓		
<b>Implements</b>	✓		
<b>Materials</b>	✓		
<b>Fields</b>	✓	✓	✓
<b>Guidance Lines</b>	✓	✓	✓
<b>Tasks</b>	✓		
<b>Users</b>	✓		
<b>Diagnostics</b>	✓		
<b>Screenshots</b>	✓		
<b>Prescriptions</b>	✓		
<b>Point/Line/Area</b>	✓	✓	✓

## Delete a Precision-IQ Resource

**NOTE** - Only Precision-IQ folders and resources (AgData) can be deleted from your display or USB drive.

You can use the Data Transfer screen to delete configuration files from Precision-IQ or your USB drive.

1. On the Data Transfer screen, tap the **Delete** action in the upper-left corner of the screen:

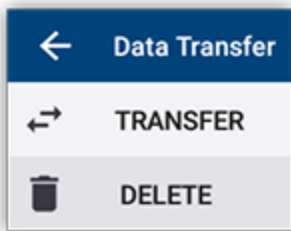

**NOTE** - The Transfer action is selected by default. When you tap Delete, the Copy button will automatically update to be Delete.

2. Drill down or expand the folders that contain the resources you want to delete and select them. (You can select resources from the Precision-IQ display, USB drive, but not both at the same time.)
3. Tap the **Delete** button at the bottom of the screen.

# Auxiliary Attachments

## ▶ External Camera

GFX/XCN displays with the appropriate connections support auxiliary attachments - such as external cameras. These devices are then available through Precision-IQ.



# External Camera

GFX/XCN displays with the appropriate connector support external cameras (both PAL and NTSC formats).



**NTSC**- National Television Standards Committee, used in North America.

**PAL** - Phase Alternating Line, standard analog video used in Europe and Asia.



Connector	Function
1	<p><b>Auxiliary Connectors</b> (for radar, implement switches, FarmStream, cameras, etc.). These connectors may be red, black, or blue, depending on the GFX/XCN model:</p>  <p><b>Note:</b> The 7-inch display only has one auxiliary connector.</p> <p>See the table below for the cable needed for your model.</p>
2	Power In
3	Connects to GNSS receiver

## Cables

GFX-350/750 and XCN-750/1050 Displays	GFX-1060/1260 and XCN-1060/1260 Displays
 <p data-bbox="402 871 516 903"><b>114078</b></p> <p data-bbox="207 913 711 1024">Cable Assy, GFX-350/750/XCN-750/1050, Expansion Port Multi, Dig I/O, RS232, Analog AgCam, 2.5m</p>	 <p data-bbox="1068 871 1182 903"><b>121907</b></p> <p data-bbox="922 913 1328 1024">Cable Assy, GFX/XCN, Base Cable, Expansion Port II , CAN, Dig I/O, Analog AgCam, 2.5m</p>

The GFX/XCN displays support a variety of third-party cameras - such as the Dakota Micro AgCam pictured below - with the appropriate cable:



